

### Eagle Quantum® Premier 8 Channel Discrete Input/Output Module (DCIO) EQ3700DCIO

#### DESCRIPTION

The 8 Channel DCIO Module is specially designed to expand the Input and Output capability of the Det-Tronics Eagle Quantum Premier® System.

The unit is designed to provide continuous and automated fire/gas protection, while ensuring system operation through continuous supervision of System Inputs/Outputs and Local Operating Network/Signalling Line Circuit (LON/SLC) monitoring in the controller.

The DCIO module provides eight channels of configurable input or output points that can be programmed for supervised or unsupervised operation. Each input point can accept fire detection devices such as heat, smoke, or unitized flame detectors. Each output point can be configured for signaling or releasing output operation. Each channel on the module is provided with individual indicators for active and fault conditions.

#### NOTE

*An input must be active for at least 750 milliseconds in order to be recognized.*

The DCIO module can be mounted directly to a panel, or it can be DIN rail mounted. System status can be determined using the trouble-shooting procedures, Eagle Quantum Safety System Software (S<sup>3</sup>) and the status indicators on the module.



#### THEORY OF OPERATION

Each channel on the DCIO module can be configured as an input to accept a connection from manual alarm stations, heat sensors, smoke sensors, pressure sensors, or as an output for notification or releasing.

Both input and output circuits can be configured as either a supervised or an unsupervised point. Each input point is also assigned a circuit type, such as: Alarm, Trouble, Supervisory, Gas High or Low Alarm, or other. The DCIO module reports to the EQP Controller and activates the appropriate static or user logic in the EQP Controller.

The DCIO module supports ANSI/NFPA Class A, Style 7 communications with the Eagle Quantum Premier Controller.

To ensure reliable system operation, the module continuously monitors its input and output circuits for opens and short circuit conditions. The Eagle Quantum Premier Controller also continuously monitors the status of the DCIO module as well as the status of each device connected to the DCIO module.

## LED INDICATORS

LEDs on the front panel of the DCIO are provided for indicating device status conditions. The LED's are tested upon power up to verify their operation. Red LEDs indicate an active condition. Yellow LEDs indicate trouble.

## MOUNTING

The DCIO module is DIN rail or direct panel mountable for configurations requiring installation in NEMA or IP enclosures. DIN rail and mounting clip options must be specified at the time of order. Refer to the "Specifications" section for mounting arrangements and dimensions.

## FEATURES

- Expands the capabilities of the Det-Tronics Eagle Quantum Premier system
- Monitors eight independent I/O channels
- Individual channels are configurable as an Input or Output
- Individual channels are configurable as supervised or unsupervised points
- Individual point Type is configurable for alarm/supervisory/other input styles, notification/releasing output
- Individual channel LEDs indicate Active and Fault status
- Provides remote I/O capabilities via LON/SLC
- Panel or DIN rail mounting
- Power LED display
- Plug-in wiring connectors
- Meets the requirements of NFPA 72
- RFI and EMI hardened (CE Marked).

## SPECIFICATIONS

### POWER REQUIREMENTS—

3 watts nominal, 7 watts maximum.

### INPUT VOLTAGE—

24 vdc nominal, 18 to 30 vdc. 10% overvoltage will not cause damage to the equipment.

### SLC OUTPUT—

Digital communication, transformer isolated (78.5 kbps).

### TEMPERATURE RANGE—

Operating:  $-40^{\circ}\text{F}$  to  $+185^{\circ}\text{F}$  ( $-40^{\circ}\text{C}$  to  $+85^{\circ}\text{C}$ ).  
Storage:  $-67^{\circ}\text{F}$  to  $+185^{\circ}\text{F}$  ( $-55^{\circ}\text{C}$  to  $+85^{\circ}\text{C}$ ).

### HUMIDITY RANGE—

0 to 95% RH, non-condensing.

### VIBRATION—

FM 3260-2000 (clause 4.9).

### DIMENSIONS—

Refer to Figure 1.

### SHIPPING WEIGHT—

1 pound (0.45 kilograms).

### CERTIFICATION—

FM / CSA: Class I, Div. 2, Groups A, B, C, D (T4).  
Class I, Zone 2, Group IIC (T4).

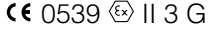
ATEX/CE: ATEX/EMC Directive Compliant.  
CE 0539  II 3 G  
EEx nC IIC T4  
DEMKO 02 ATEX 133864U  
T4 (Tamb =  $-40^{\circ}\text{C}$  to  $+85^{\circ}\text{C}$ ).

### Special conditions for safe use:

The device shall be installed in an enclosure that complies with all relevant requirements of EN 50021: 1999, and provides a degree of ingress protection of at least IP54. The device may only be installed, connected or removed when the area is known to be non-hazardous.



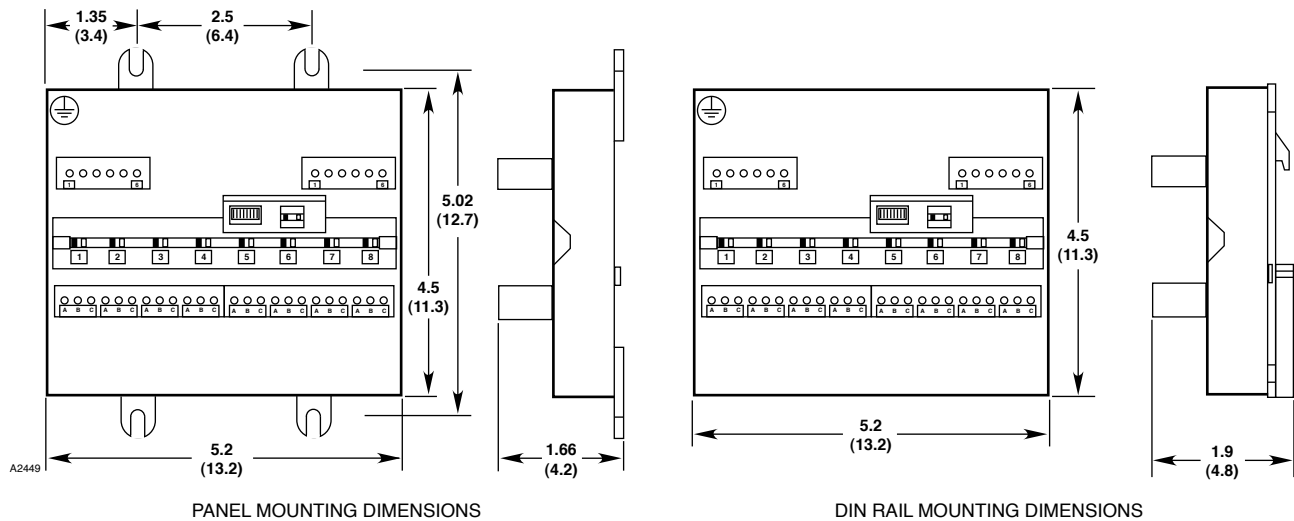

Figure 1—Dimensions of the DCIO Module in Inches (Centimeters)

## INPUT / INITIATING DEVICE CIRCUITS

### UNSUPERVISED INPUT—

Two state input (on/off).  
Normally open contact.

### SUPERVISED INPUT, CLASS B STYLE B—

Two state input (active/trouble):

- End of Line Resistor 10 K ohms nominal
- Open Circuit > 45 K ohms
- Active Circuit < 5 K ohms.

### SUPERVISED INPUT, CLASS B STYLE C—

Three State input (active/short/open):

- End of Line Resistor 10 K ohms nominal
- In Line Resistor 3.3 K ohms nominal
- Open Circuit > 45 K ohms
- Short Circuit < 1.4 K ohms
- Active Circuit 2.5 K ohms to 5 K ohms.

### INPUT, TYPES—

Configurable for static logic applications:

- Fire Alarm
- Supervisory
- Trouble
- High Gas Alarm
- Low Gas Alarm
- Other.

## OUTPUT / NOTIFICATION / RELEASING OR UNSUPERVISED DEVICE CIRCUITS

### UNSUPERVISED OUTPUT RATING—

Rating: 2 amperes at 30 Vdc maximum.

Note: Voltage available at outputs is dependent on input voltage ( $V_{out} \approx V_{in} - 1 \text{ Vdc}$ ).

### OUTPUT STYLE—

Form "A" normally off.

### RESPONSE TIME—

Output actuates in <0.15 second after acknowledging an alarm command message.

## SUPERVISED OUTPUT RATING—SIGNALING TYPE, STYLE "Y"

### MAXIMUM OUTPUT CURRENT—

2 amperes at 30 Vdc maximum, 15 Amp inrush.

Automatic short circuit protection provided.

### SUPERVISORY CURRENT—

Reverse current monitored at 1.5 mA,  $\pm 0.5 \text{ mA}$ .

### RESPONSE TIME—

Output actuates in <0.15 second after acknowledging an alarm command message.

### EOL RESISTORS—

10 K ohms  $\pm 2 \text{ K ohms}$ . Each circuit must have an EOL resistor.

### SIGNALING OUTPUT, TYPES—

Configurable for device applications:

- Continuous
- 60 beats per minute
- 120 beats per minute
- Temporal Pattern.

Note: All eight channels are synchronized when programmed as a signaling output.

### SUPERVISED OUTPUT RATING— Releasing Type

#### MAXIMUM OUTPUT CURRENT—

2 amperes at 30 Vdc maximum, 15 Amp inrush.  
Automatic short circuit protection provided.

#### SUPERVISORY CURRENT—

Monitored at 1.3 mA ±0.2 mA.

#### RESPONSE TIME—

Output actuates in <0.15 second after acknowledging an alarm command message.

### RELEASING OUTPUT, TYPES—

Configurable for device applications:

- Continuous
- Timed.

## INSTALLATION

All electrical connections are made to the field wiring connectors furnished with the module. Refer to Figure 2 for identification of module wiring terminals.

### Connector P1, Terminals 1 to 6 24 Vdc Power Input

Connect the module power supply to terminals 1 and 2. If additional terminals are required for powering other devices, these devices should be connected to terminals 4 and 5. Shields are to be connected to terminals 3 and 6 — chassis (earth) ground terminals. Terminals are rated for 10 amperes. Use both sets of input terminals in parallel if total output current can exceed 10 amperes.

### Connector P2, Terminals 1 to 6 LON/SLC Signaling Circuit Terminals

Be sure to observe polarity when wiring the LON/SLC shield connection — terminals 3 and 6.

- 1 — "A" side of signaling circuit for COM 1
- 2 — "B" side of signaling circuit for COM 1
- 4 — "A" side of signaling circuit for COM 2
- 5 — "B" side of signaling circuit for COM 2

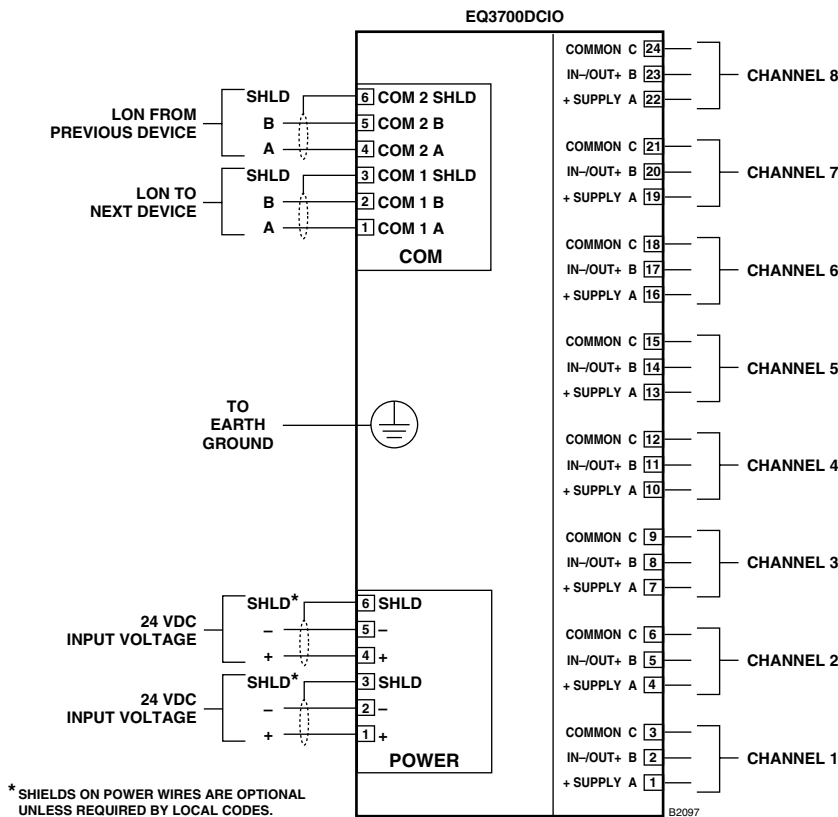

Figure 2—DCIO Module Wiring Terminal Configuration

**Connector P3, Terminals 1 to 12**  
**Terminals A,B & C**  
**Channels 1 to 4 Input / Output Terminals**

Refer to individual wiring configurations for terminal descriptions. Only channel 1 is shown in each diagram. The information is typical for channels 2-8.

**Connector P4, Terminals 13 to 24**  
**Terminals A, B & C**  
**Channels 5 to 8 Input / Output Terminals**

Refer to individual wiring configurations for terminal descriptions. Only channel 1 is shown in each diagram. The information is typical for channels 2-8.

**Unsupervised Input**

Connect external system wiring to the appropriate terminals on the terminal block. See Figure 3.

The input to the DCIO consists of one or more normally open or normally closed switches. An EOL resistor is not required.

No connection should be made to “+ Supply” terminal.

**NFPA - Class B, Style B**  
**(Two State – Open and Switch Closure)**

**Supervised Input (IDC) Open Circuit Supervision**

Connect external system wiring to the appropriate terminals on the terminal block. See Figure 4.

The input to the DCIO module consists of one or more normally open switches, with a 10 K ohm, 1/4 watt EOL resistor in parallel across the last switch.

No connection should be made to “+ Supply” terminal.

**NFPA - Class B Style C**  
**(Three state – open, switch closure, and short)**

**Supervised Input (IDCSC) Open and Short Circuit Supervision**

Connect external system wiring to the appropriate terminals on the terminal block. See Figure 5.

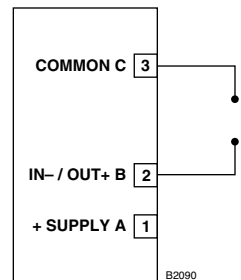

Figure 3—Unsupervised Input Configuration

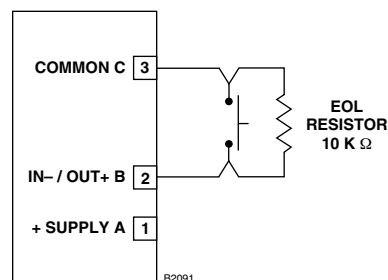

Figure 4—Supervised Input Configuration

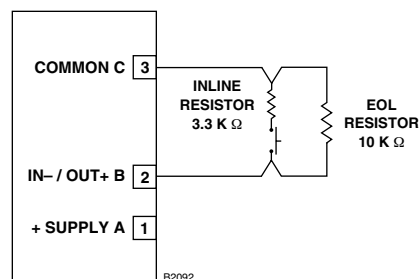

Figure 5—Supervised Input Configuration (Opens and Shorts)

The input to the DCIO module consists of one or more normally open switches, with a 10 K ohm, 1/4 watt EOL resistor in parallel across the last switch and a 3.3 K ohm, 1/4 watt in-line resistor with each switch in the circuit.

No connection should be made to “+ Supply” terminal.

## Unsupervised Output

Connect external system wiring to the appropriate terminals on the terminal block. See Figure 6.

No connection should be made to “+ Supply” terminal.

## Supervised Output

### Notification Supervised for Open & Short Circuits

Connect external system wiring to the appropriate terminals on the terminal block. See Figure 7.

The output of the DCIO module supervises the notification circuit by reversing the polarity of the monitoring circuit. Polarity must be observed when connecting the notification device. It is essential to utilize a notification device approved for fire alarm notification. These devices are polarized and would not require the use of an external diode for the supervision of the circuit. Wire one or more notification devices to the output, with a 10 K ohm, 1/4 watt EOL resistor in parallel across the last device.

No connection should be made to “+ Supply” terminal.

Each output channel is individually activated for response pattern:

- supervisory
- continuous output
- 60 beats per minute
- 120 beats per minute
- temporal
- timed
- trouble.

## Supervised Output

### Agent Release

Connect external system wiring to the appropriate terminals on the terminal block. See Figure 8

Wire one or more releasing devices to the module output.

No connection should be made to “+ Supply” terminal.

The output of the DCIO module supervises the releasing circuit via the coil of the releasing solenoid. It is essential to utilize a releasing device approved for use with this output module. This type of output does not require the use of EOL resistors or diodes to supervise the circuit.

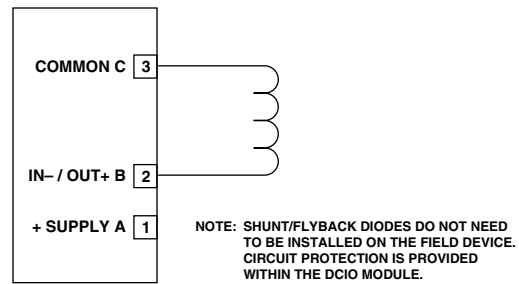

Figure 6—Unsupervised Output Configuration

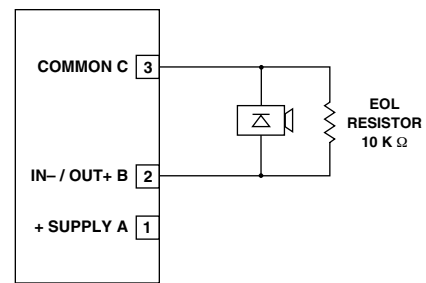

Figure 7—Supervised Output Configuration (Notification)

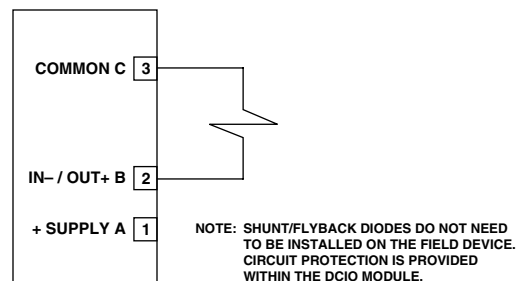

Figure 8—Supervised Output Configuration (Agent Release)

The output can be configured for latching, continuous, supervisory, trouble or timed response.

To ensure adequate operating voltage for the output device, the maximum wiring length from the power source to the output device must not exceed the values shown in Table 1 for automatic release applications or Table 2 for deluge and pre-action applications. (For solenoids, this wire length includes both the wiring from the power supply to the DCIO module and the wiring from the module to the solenoid.)

### NOTE

*Squibs are not compatible with this output. If squib actuation is required, use EQ2500ARM release module.*

Table 1—Maximum Wire Length for Releasing Applications

Device	Maximum Wire Length in Feet			
	12 AWG	14 AWG	16 AWG	18 AWG
890181*	150	100	60	
899175*	150	100	60	
895630-000*	150	100	60	
897494*	190	120	75	
486500-001*	1500	1000	600	400
31-199932-004*	150	100	60	
2 Amp Load	190	120	75	

\*Fenwal Solenoid

Table 2—Maximum Wire Length for FM Approved Solenoids for Deluge and Pre-Action Applications

Solenoids			Maximum Wire Length in Feet (Meters)			
FM Solenoid Group	Manufacturer	Model	12 AWG	14 AWG	16 AWG	18 AWG
B	ASCO	T8210A107	183 (56)	115 (35)	72 (22)	46 (14)
D	ASCO	8210G207	314 (96)	198 (60)	124 (38)	78 (24)
E	Skinner	73218BN4UNLVNOC111C2	331 (101)	208 (63)	131 (40)	82 (25)
F	Skinner	73212BN4TNLVNOC322C2	130 (40)	82 (25)	51 (16)	32 (10)
G	Skinner	71395SN2ENJ1NOH111C2	331 (101)	208 (63)	131 (40)	82 (25)
H	Viking	HV-274-0601	180 (55)	110 (34)	70 (21)	45(14)

## ORDERING INFORMATION

When ordering, please specify:

EQ3700DCIO      8 Channel Discrete Input/Output  
Module

Options            Panel Mount  
                      DIN Rail Mount  
                      EOL Resistors

Detector Electronics Corporation  
6901 West 110th Street  
Minneapolis, Minnesota 55438 USA  
Operator: (952) 941-5665 or (800) 765-FIRE  
Customer Service: (952) 946-6491  
Fax: (952) 829-8750  
Web site: www.det-tronics.com  
E-mail: det-tronics@det-tronics.com

For additional information or for assistance in designing a system to meet the needs of a specific application, please contact:

Specifications subject to change without notice.

Det-Tronics, the DET-TRONICS logo, and Eagle Quantum Premier are registered trademarks or trademarks of Detector Electronics Corporation in the United States, other countries, or both. Other company, product, or service names may be trademarks or service marks of others.

©Copyright Detector Electronics Corporation 2004. All rights reserved.



## **Detector Electronics Corporation**

6901 West 110th Street • Minneapolis, Minnesota 55438 USA

Operator: (952) 941-5665 or (800) 765-FIRE

Customer Service: (952) 946-6491 • Fax (952) 829-8750

<http://www.det-tronics.com> • E-mail: [det-tronics@det-tronics.com](mailto:det-tronics@det-tronics.com)