



**Section B - Sprinklers**  
**Standard Coverage, Quick Response**

**TABLE OF CONTENTS**

|                                 |  |
|---------------------------------|--|
| Pendent/Upright<br>(glass bulb) | VK325/VK329, 2.8 (40) K factor, upright / pendent ..... B-1<br>VK327/VK331, 4.2 (60) K factor, upright / pendent ..... B-2<br>VK300/VK302, 5.6 (81) K factor, upright / pendent ..... B-3<br>VK350/VK352, 8.0 (115) K factor, upright / pendent (3/4" NPT) ..... B-4<br>VK350/VK352, 8.0 (115) K factor, upright / pendent (1/2" NPT) - REPLACEMENT ..... B-5  |
| Conventional                    | VK310/VK354, 5.6 (81) / 8.0 (115) K factor, conventional ..... B-6   |
| Sidewall                        | VK333, 2.8 (40) K factor, horizontal sidewall ..... B-7<br>VK305/VK306, 5.6 (81) K factor, horizontal sidewall / vertical sidewall ..... B-8<br>VK360, 8.0 (115) K factor, horizontal sidewall ..... B-8   |
| Concealed                       | VK302-D/VK352-D, 5.6 (81) / 8.0 (115) K factor, domed concealed pendent ..... B-9<br>VK402, 5.6 (81) K factor, flush pendent ..... B-9<br>Mirage® VK461/VK465, 2.8 (40) / 4.2 (60) K factor, flat concealed pendent ..... B-10<br>Mirage® VK462/VK464, 5.6 (81) / 8.0 (115) K factor, flat concealed pendent ..... B-10<br>Mirage® VK463, 5.6 (81) K factor, flat concealed pendent, high pressure ..... B-10<br>Mirage® VK469, 11.2 (161) K factor, ELO, flat concealed pendent ..... B-10<br>Mirage® MRI Room Concealed Sprinklers (VK462/VK464) ..... B-10<br>Mirage® Cover Plates (standard, large, square, ELO, clean room) ..... B-11<br>Mirage® Adjustable Concealed Sprinklers (VK461/VK465/VK462) ..... B-12<br>VK481, 5.6 (81) K factor, flat concealed horizontal sidewall and cover plate ..... B-13 |
| Fusible Link                    | Fusible Link, upright / pendent ..... B-14<br>Fusible Link, horizontal sidewall / vertical sidewall / conventional ..... B-15<br>Fusible Link, high pressure ..... B-16  |
| High Pressure                   | VK340/VK342, high pressure, 2.8 (40) K factor, upright / pendent, HP ..... B-17<br>VK315/VK317, high pressure, 5.6 (81) K factor, upright / pendent, HP ..... B-18<br>VK344/VK319, high pressure, 2.8 (40) / 5.6 (81) K factor, horizontal sidewall, HP ..... B-19   |
| Stainless Steel                 | VK338/VK339, stainless steel, 5.6 (81) K factor, upright / pendent ..... B-20  |
| Cocoon Spk                      | Cocoon Sprinklers, 5.6 (81) K factor, pendent / horizontal sidewall ..... B-20   |

**Notes**

1. All sprinklers in this section are available with three wraps of tape on threads. Add \$1.60 to list price for each sprinkler ordered. When ordering, add a "T" to end of part number.
2. Unless otherwise indicated, all cover plates and escutcheons are sold separately.
3. Cover plates, escutcheons, and sprinklers are available in custom colors at an additional charge. See pages F-7 and F-8 for details.
4. Refer to Viking technical data pages for complete product specifications ([www.vikinggroupinc.com](http://www.vikinggroupinc.com)).
5. List prices effective April 7, 2012. Supersedes April 2011 list price book.
6. All sales by Viking are subject to the Terms & Conditions found on the last page of this book.

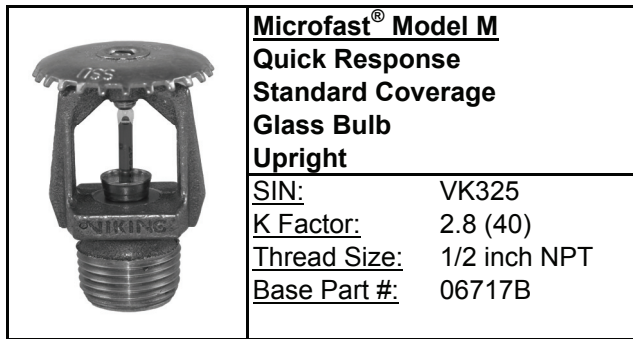

**Microfast® Model M**  
**Quick Response**  
**Standard Coverage**  
**Glass Bulb**  
**Upright**

**SIN:** VK325  
**K Factor:** 2.8 (40)  
**Thread Size:** 1/2 inch NPT  
**Base Part #:** 06717B

| Finish                               | Temp  | Part #     | IPG   | List Price |
|--------------------------------------|-------|------------|-------|------------|
| Standard Brass                       | 155°F | 06717BAB   | V14.2 | \$43.11    |
| Standard Brass                       | 175°F | 06717BAD   | V14.2 | \$43.11    |
| Standard Brass                       | 200°F | 06717BAE   | V14.2 | \$43.11    |
| Standard Brass                       | 286°F | 06717BAG   | V14.2 | \$43.11    |
| Chrome                               | 155°F | 06717BFB   | V14.2 | \$46.20    |
| Chrome                               | 175°F | 06717BFD   | V14.2 | \$46.20    |
| Chrome                               | 200°F | 06717BFE   | V14.2 | \$46.20    |
| Chrome                               | 286°F | 06717BFG   | V14.2 | \$46.20    |
| White-Polyester <sup>1</sup>         | 155°F | 06717BMB/W | V14.2 | \$46.20    |
| White-Polyester                      | 175°F | 06717BMD/W | V14.2 | \$46.20    |
| White-Polyester                      | 200°F | 06717BME/W | V14.2 | \$46.20    |
| White-Polyester                      | 286°F | 06717BMG/W | V14.2 | \$46.20    |
| Black-Polyester <sup>1</sup>         | 155°F | 06717BMB/B | V20   | \$48.01    |
| Black-Polyester                      | 175°F | 06717BMD/B | V20   | \$48.01    |
| Black-Polyester                      | 200°F | 06717BME/B | V20   | \$48.01    |
| Black-Polyester                      | 286°F | 06717BMG/B | V20   | \$48.01    |
| Black (flouropolymer) <sup>1,2</sup> | 155°F | 06717BNB   | V20   | \$58.37    |
| Black (flouropolymer) <sup>1,2</sup> | 175°F | 06717BND   | V20   | \$58.37    |
| Black (flouropolymer) <sup>1,2</sup> | 200°F | 06717BNE   | V20   | \$58.37    |
| Black (flouropolymer) <sup>1,2</sup> | 286°F | 06717BNG   | V20   | \$58.37    |
| Std sprinkler Wrench                 |       | 10896W/B   | V20   | \$56.27    |

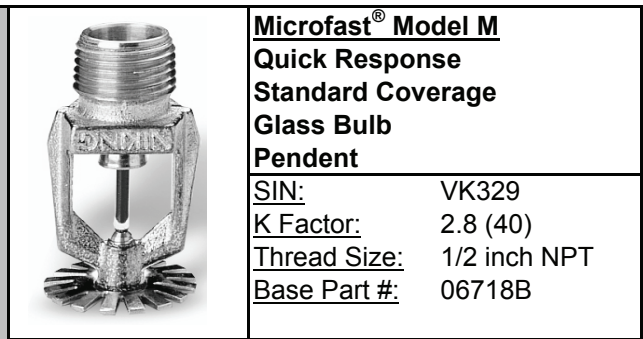

**Microfast® Model M**  
**Quick Response**  
**Standard Coverage**  
**Glass Bulb**  
**Pendent**

**SIN:** VK329  
**K Factor:** 2.8 (40)  
**Thread Size:** 1/2 inch NPT  
**Base Part #:** 06718B

| Finish                               | Temp  | Part #     | IPG   | List Price |
|--------------------------------------|-------|------------|-------|------------|
| Standard Brass                       | 155°F | 06718BAB   | V14.2 | \$43.11    |
| Standard Brass                       | 175°F | 06718BAD   | V14.2 | \$43.11    |
| Standard Brass                       | 200°F | 06718BAE   | V14.2 | \$43.11    |
| Standard Brass                       | 286°F | 06718BAG   | V14.2 | \$43.11    |
| Chrome                               | 155°F | 06718BFB   | V14.2 | \$46.20    |
| Chrome                               | 175°F | 06718BFD   | V14.2 | \$46.20    |
| Chrome                               | 200°F | 06718BFE   | V14.2 | \$46.20    |
| Chrome                               | 286°F | 06718BFG   | V14.2 | \$46.20    |
| White-Polyester <sup>1</sup>         | 155°F | 06718BMB/W | V14.2 | \$46.20    |
| White-Polyester                      | 175°F | 06718BMD/W | V14.2 | \$46.20    |
| White-Polyester                      | 200°F | 06718BME/W | V14.2 | \$46.20    |
| White-Polyester                      | 286°F | 06718BMG/W | V14.2 | \$46.20    |
| Black-Polyester <sup>1</sup>         | 155°F | 06718BMB/B | V20   | \$48.01    |
| Black-Polyester                      | 175°F | 06718BMD/B | V20   | \$48.01    |
| Black-Polyester                      | 200°F | 06718BME/B | V20   | \$48.01    |
| Black-Polyester                      | 286°F | 06718BMG/B | V20   | \$48.01    |
| Black (flouropolymer) <sup>1,2</sup> | 155°F | 06718BNB   | V20   | \$58.37    |
| Black (flouropolymer) <sup>1,2</sup> | 175°F | 06718BND   | V20   | \$58.37    |
| Black (flouropolymer) <sup>1,2</sup> | 200°F | 06718BNE   | V20   | \$58.37    |
| Black (flouropolymer) <sup>1,2</sup> | 286°F | 06718BNG   | V20   | \$58.37    |
| Std sprinkler Wrench                 |       | 10896W/B   | V20   | \$56.27    |
| Wrench for Rcsd w/Caps               |       | 16036W/B   | V20   | \$115.04   |

(1) Suitable for decorative applications and are UL listed for corrosion resistance.  
(2) Also available with coated waterways without glass bulbs.

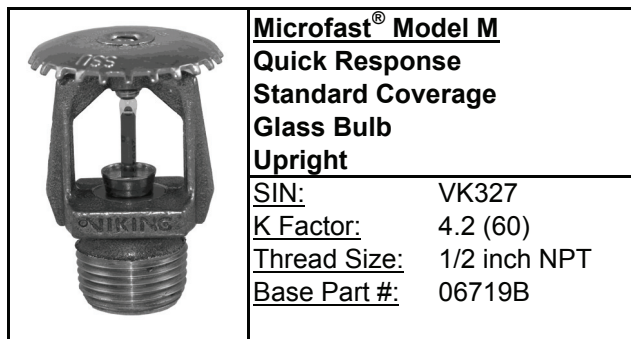

**Microfast® Model M**  
**Quick Response**  
**Standard Coverage**  
**Glass Bulb**  
**Upright**  
SIN: VK327  
K Factor: 4.2 (60)  
Thread Size: 1/2 inch NPT  
Base Part #: 06719B

| Finish                               | Temp  | Part #     | IPG   | List Price |
|--------------------------------------|-------|------------|-------|------------|
| Standard Brass                       | 155°F | 06719BAB   | V14.2 | \$41.54    |
| Standard Brass                       | 175°F | 06719BAD   | V14.2 | \$41.54    |
| Standard Brass                       | 200°F | 06719BAE   | V14.2 | \$41.54    |
| Standard Brass                       | 286°F | 06719BAG   | V14.2 | \$41.54    |
| Chrome                               | 155°F | 06719BFB   | V14.2 | \$44.52    |
| Chrome                               | 175°F | 06719BFD   | V14.2 | \$44.52    |
| Chrome                               | 200°F | 06719BFE   | V14.2 | \$44.52    |
| Chrome                               | 286°F | 06719BFG   | V14.2 | \$44.52    |
| White-Polyester <sup>1</sup>         | 155°F | 06719BMB/W | V14.2 | \$44.52    |
| White-Polyester                      | 175°F | 06719BMD/W | V14.2 | \$44.52    |
| White-Polyester                      | 200°F | 06719BME/W | V14.2 | \$44.52    |
| White-Polyester                      | 286°F | 06719BMG/W | V14.2 | \$44.52    |
| Black-Polyester <sup>1</sup>         | 155°F | 06719BMB/B | V20   | \$46.25    |
| Black-Polyester                      | 175°F | 06719BMD/B | V20   | \$46.25    |
| Black-Polyester                      | 200°F | 06719BME/B | V20   | \$46.25    |
| Black-Polyester                      | 286°F | 06719BMG/B | V20   | \$46.25    |
| Black (flouropolymer) <sup>1,2</sup> | 155°F | 06719BNB   | V20   | \$56.24    |
| Black (flouropolymer) <sup>1,2</sup> | 175°F | 06719BND   | V20   | \$56.24    |
| Black (flouropolymer) <sup>1,2</sup> | 200°F | 06719BNE   | V20   | \$56.24    |
| Black (flouropolymer) <sup>1,3</sup> | 286°F | 06719BNG   | V20   | \$56.24    |
| Std Sprinkler Wrench                 |       | 10896W/B   | V20   | \$56.27    |

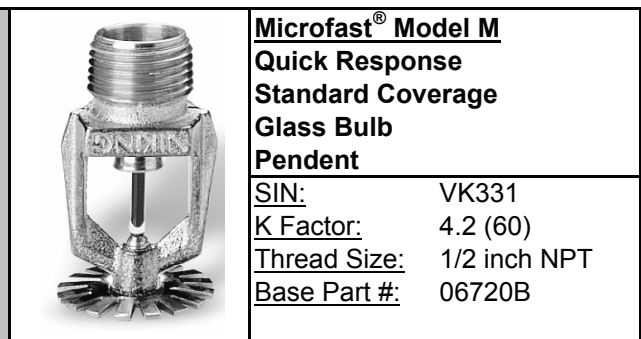

**Microfast® Model M**  
**Quick Response**  
**Standard Coverage**  
**Glass Bulb**  
**Pendent**  
SIN: VK331  
K Factor: 4.2 (60)  
Thread Size: 1/2 inch NPT  
Base Part #: 06720B

| Finish                               | Temp  | Part #     | IPG   | List Price |
|--------------------------------------|-------|------------|-------|------------|
| Standard Brass                       | 155°F | 06720BAB   | V14.2 | \$41.54    |
| Standard Brass                       | 175°F | 06720BAD   | V14.2 | \$41.54    |
| Standard Brass                       | 200°F | 06720BAE   | V14.2 | \$41.54    |
| Standard Brass                       | 286°F | 06720BAG   | V14.2 | \$41.54    |
| Chrome                               | 155°F | 06720BFB   | V14.2 | \$44.52    |
| Chrome                               | 175°F | 06720BFD   | V14.2 | \$44.52    |
| Chrome                               | 200°F | 06720BFE   | V14.2 | \$44.52    |
| Chrome                               | 286°F | 06720BFG   | V14.2 | \$44.52    |
| White-Polyester <sup>1</sup>         | 155°F | 06720BMB/W | V14.2 | \$44.52    |
| White-Polyester                      | 175°F | 06720BMD/W | V14.2 | \$44.52    |
| White-Polyester                      | 200°F | 06720BME/W | V14.2 | \$44.52    |
| White-Polyester                      | 286°F | 06720BMG/W | V14.2 | \$44.52    |
| Black-Polyester <sup>1</sup>         | 155°F | 06720BMB/B | V20   | \$46.25    |
| Black-Polyester                      | 175°F | 06720BMD/B | V20   | \$46.25    |
| Black-Polyester                      | 200°F | 06720BME/B | V20   | \$46.25    |
| Black-Polyester                      | 286°F | 06720BMG/B | V20   | \$46.25    |
| Black (flouropolymer) <sup>1,2</sup> | 155°F | 06720BNB   | V20   | \$56.24    |
| Black (flouropolymer) <sup>1,2</sup> | 175°F | 06720BND   | V20   | \$56.24    |
| Black (flouropolymer) <sup>1,2</sup> | 200°F | 06720BNE   | V20   | \$56.24    |
| Black (flouropolymer) <sup>1,3</sup> | 286°F | 06720BNG   | V20   | \$56.24    |
| Std Sprinkler Wrench                 |       | 10896W/B   | V20   | \$56.27    |
| Wrench for Rcsd w/Caps               |       | 16036W/B   | V20   | \$115.04   |

(1) Suitable for decorative applications and are UL listed for corrosion resistance.  
(2) Also available with coated waterways without glass bulbs.

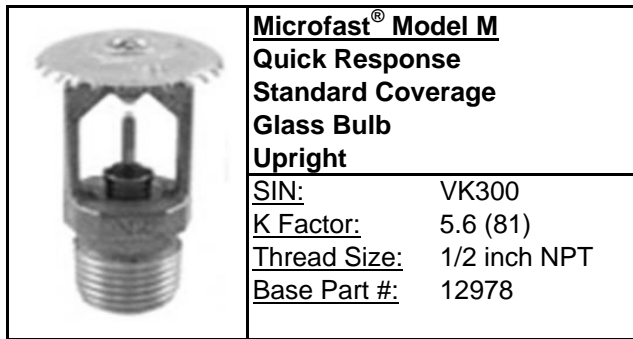

**Microfast® Model M**  
**Quick Response**  
**Standard Coverage**  
**Glass Bulb**  
**Upright**

**SIN:** VK300  
**K Factor:** 5.6 (81)  
**Thread Size:** 1/2 inch NPT  
**Base Part #:** 12978

| Finish                               | Temp  | Part #    | IPG   | List Price |
|--------------------------------------|-------|-----------|-------|------------|
| Standard Brass                       | 135°F | 12978AA   | V13   | \$34.82    |
| Standard Brass                       | 155°F | 12978AB   | V13   | \$34.82    |
| Standard Brass                       | 175°F | 12978AD   | V13   | \$34.82    |
| Standard Brass                       | 200°F | 12978AE   | V13   | \$34.82    |
| Standard Brass                       | 286°F | 12978AG   | V13   | \$34.82    |
| Chrome                               | 135°F | 12978FA   | V13.1 | \$37.66    |
| Chrome                               | 155°F | 12978FB   | V13.1 | \$37.66    |
| Chrome                               | 175°F | 12978FD   | V13.1 | \$37.66    |
| Chrome                               | 200°F | 12978FE   | V13.1 | \$37.66    |
| Chrome                               | 286°F | 12978FG   | V13.1 | \$37.66    |
| White-Polyester <sup>1</sup>         | 135°F | 12978MA/W | V13.2 | \$37.66    |
| White-Polyester                      | 155°F | 12978MB/W | V13.2 | \$37.66    |
| White-Polyester                      | 175°F | 12978MD/W | V13.2 | \$37.66    |
| White-Polyester                      | 200°F | 12978ME/W | V13.2 | \$37.66    |
| White-Polyester                      | 286°F | 12978MG/W | V13.2 | \$37.66    |
| Black-Polyester <sup>1</sup>         | 135°F | 12978MA/B | V20   | \$39.12    |
| Black-Polyester                      | 155°F | 12978MB/B | V20   | \$39.12    |
| Black-Polyester                      | 175°F | 12978MD/B | V20   | \$39.12    |
| Black-Polyester                      | 200°F | 12978ME/B | V20   | \$39.12    |
| Black-Polyester                      | 286°F | 12978MG/B | V20   | \$39.12    |
| Black (flouropolymer) <sup>1,2</sup> | 135°F | 12978NA   | V20   | \$50.46    |
| Black (flouropolymer) <sup>1,2</sup> | 155°F | 12978NB   | V20   | \$50.46    |
| Black (flouropolymer) <sup>1,2</sup> | 175°F | 12978ND   | V20   | \$50.46    |
| Black (flouropolymer) <sup>1,2</sup> | 200°F | 12978NE   | V20   | \$50.46    |
| Black (flouropolymer) <sup>1,3</sup> | 286°F | 12978NG   | V20   | \$50.46    |
| Std Sprinkler Wrench                 |       | 10896W/B  | V20   | \$56.27    |

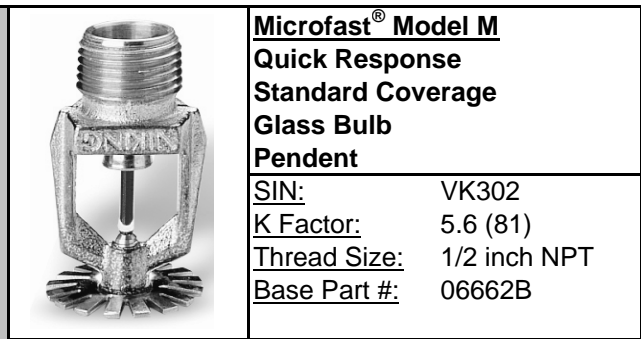

**Microfast® Model M**  
**Quick Response**  
**Standard Coverage**  
**Glass Bulb**  
**Pendant**

**SIN:** VK302  
**K Factor:** 5.6 (81)  
**Thread Size:** 1/2 inch NPT  
**Base Part #:** 06662B

| Finish                               | Temp  | Part #     | IPG   | List Price |
|--------------------------------------|-------|------------|-------|------------|
| Standard Brass                       | 135°F | 06662BAA   | V13   | \$34.82    |
| Standard Brass                       | 155°F | 06662BAB   | V13   | \$34.82    |
| Standard Brass                       | 175°F | 06662BAD   | V13   | \$34.82    |
| Standard Brass                       | 200°F | 06662BAE   | V13   | \$34.82    |
| Standard Brass                       | 286°F | 06662BAG   | V13   | \$34.82    |
| Chrome                               | 135°F | 06662BFA   | V13.1 | \$37.66    |
| Chrome                               | 155°F | 06662BFB   | V13.1 | \$37.66    |
| Chrome                               | 175°F | 06662BFD   | V13.1 | \$37.66    |
| Chrome                               | 200°F | 06662BFE   | V13.1 | \$37.66    |
| Chrome                               | 286°F | 06662BFG   | V13.1 | \$37.66    |
| White-Polyester <sup>1</sup>         | 135°F | 06662BMA/W | V13.2 | \$37.66    |
| White-Polyester                      | 155°F | 06662BMB/W | V13.2 | \$37.66    |
| White-Polyester                      | 175°F | 06662BMD/W | V13.2 | \$37.66    |
| White-Polyester                      | 200°F | 06662BME/W | V13.2 | \$37.66    |
| White-Polyester                      | 286°F | 06662BMG/W | V13.2 | \$37.66    |
| Black-Polyester <sup>1</sup>         | 135°F | 06662BMA/B | V20   | \$39.12    |
| Black-Polyester                      | 155°F | 06662BMB/B | V20   | \$39.12    |
| Black-Polyester                      | 175°F | 06662BMD/B | V20   | \$39.12    |
| Black-Polyester                      | 200°F | 06662BME/B | V20   | \$39.12    |
| Black-Polyester                      | 286°F | 06662BMG/B | V20   | \$39.12    |
| Black (flouropolymer) <sup>1,2</sup> | 135°F | 06662BNA   | V20   | \$50.46    |
| Black (flouropolymer) <sup>1,2</sup> | 155°F | 06662BNB   | V20   | \$50.46    |
| Black (flouropolymer) <sup>1,2</sup> | 175°F | 06662BND   | V20   | \$50.46    |
| Black (flouropolymer) <sup>1,2</sup> | 200°F | 06662BNE   | V20   | \$50.46    |
| Black (flouropolymer) <sup>1,2</sup> | 286°F | 06662BNG   | V20   | \$50.46    |
| Std Sprinkler Wrench                 |       | 10896W/B   | V20   | \$56.27    |
| Wrench for Rcstd w/Caps              |       | 16036W/B   | V20   | \$115.04   |

(1) Suitable for decorative applications and are UL listed for corrosion resistance.

(2) Also available with coated waterways without glass bulbs.

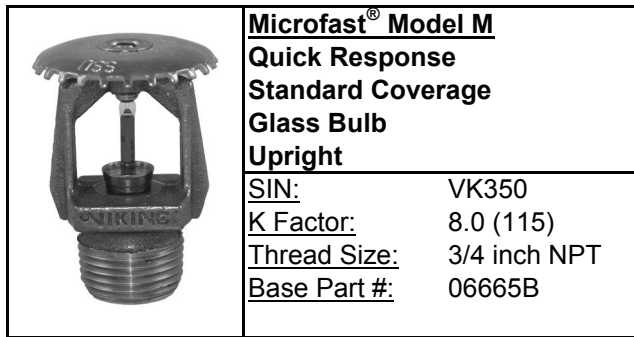

**Microfast® Model M**  
**Quick Response**  
**Standard Coverage**  
**Glass Bulb**  
**Upright**  
**SIN:** VK350  
**K Factor:** 8.0 (115)  
**Thread Size:** 3/4 inch NPT  
**Base Part #:** 06665B

| Finish                               | Temp  | Part #     | IPG | List Price |
|--------------------------------------|-------|------------|-----|------------|
| Standard Brass                       | 155°F | 06665BAB   | V14 | \$37.32    |
| Standard Brass                       | 175°F | 06665BAD   | V14 | \$37.32    |
| Standard Brass                       | 200°F | 06665BAE   | V14 | \$37.32    |
| Standard Brass                       | 286°F | 06665BAG   | V14 | \$37.32    |
| Chrome                               | 155°F | 06665BFB   | V14 | \$40.60    |
| Chrome                               | 175°F | 06665BFD   | V14 | \$40.60    |
| Chrome                               | 200°F | 06665BFE   | V14 | \$40.60    |
| Chrome                               | 286°F | 06665BFG   | V14 | \$40.60    |
| White-Polyester <sup>1</sup>         | 155°F | 06665BMB/W | V14 | \$40.60    |
| White-Polyester                      | 175°F | 06665BMD/W | V14 | \$40.60    |
| White-Polyester                      | 200°F | 06665BME/W | V14 | \$40.60    |
| White-Polyester                      | 286°F | 06665BMG/W | V14 | \$40.60    |
| Black-Polyester <sup>1</sup>         | 155°F | 06665BMB/B | V20 | \$42.19    |
| Black-Polyester                      | 175°F | 06665BMD/B | V20 | \$42.19    |
| Black-Polyester                      | 200°F | 06665BME/B | V20 | \$42.19    |
| Black-Polyester                      | 286°F | 06665BMG/B | V20 | \$42.19    |
| Black (flouropolymer) <sup>1,2</sup> | 155°F | 06665BNB   | V20 | \$53.82    |
| Black (flouropolymer) <sup>1,2</sup> | 175°F | 06665BND   | V20 | \$53.82    |
| Black (flouropolymer) <sup>1,2</sup> | 200°F | 06665BNE   | V20 | \$53.82    |
| Black (flouropolymer) <sup>1,2</sup> | 286°F | 06665BNG   | V20 | \$53.82    |
| Std Sprinkler Wrench                 |       | 10896W/B   | V20 | \$56.27    |

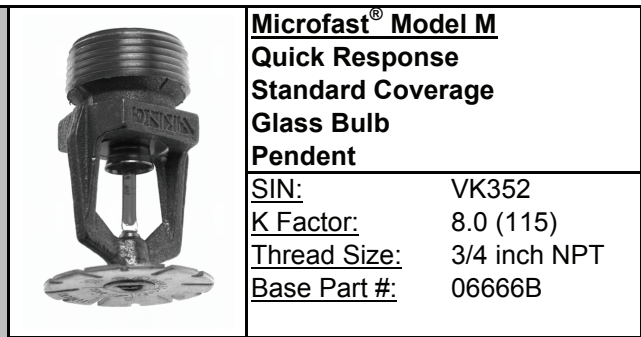

**Microfast® Model M**  
**Quick Response**  
**Standard Coverage**  
**Glass Bulb**  
**Pendent**  
**SIN:** VK352  
**K Factor:** 8.0 (115)  
**Thread Size:** 3/4 inch NPT  
**Base Part #:** 06666B

| Finish                               | Temp  | Part #     | IPG | List Price |
|--------------------------------------|-------|------------|-----|------------|
| Standard Brass                       | 155°F | 06666BAB   | V14 | \$37.32    |
| Standard Brass                       | 175°F | 06666BAD   | V14 | \$37.32    |
| Standard Brass                       | 200°F | 06666BAE   | V14 | \$37.32    |
| Standard Brass                       | 286°F | 06666BAG   | V14 | \$37.32    |
| Chrome                               | 155°F | 06666BFB   | V14 | \$40.60    |
| Chrome                               | 175°F | 06666BFD   | V14 | \$40.60    |
| Chrome                               | 200°F | 06666BFE   | V14 | \$40.60    |
| Chrome                               | 286°F | 06666BFG   | V14 | \$40.60    |
| White-Polyester <sup>1</sup>         | 155°F | 06666BMB/W | V14 | \$40.60    |
| White-Polyester                      | 175°F | 06666BMD/W | V14 | \$40.60    |
| White-Polyester                      | 200°F | 06666BME/W | V14 | \$40.60    |
| White-Polyester                      | 286°F | 06666BMG/W | V14 | \$40.60    |
| Black-Polyester <sup>1</sup>         | 155°F | 06666BMB/B | V20 | \$42.19    |
| Black-Polyester                      | 175°F | 06666BMD/B | V20 | \$42.19    |
| Black-Polyester                      | 200°F | 06666BME/B | V20 | \$42.19    |
| Black-Polyester                      | 286°F | 06666BMG/B | V20 | \$42.19    |
| Black (flouropolymer) <sup>1,2</sup> | 155°F | 06666BNB   | V20 | \$53.82    |
| Black (flouropolymer) <sup>1,2</sup> | 175°F | 06666BND   | V20 | \$53.82    |
| Black (flouropolymer) <sup>1,2</sup> | 200°F | 06666BNE   | V20 | \$53.82    |
| Black (flouropolymer) <sup>1,2</sup> | 286°F | 06666BNG   | V20 | \$53.82    |
| Std Sprinkler Wrench                 |       | 10896W/B   | V20 | \$56.27    |
| Wrench for Rcsd w/Caps               |       | 16036W/B   | V20 | \$115.04   |

(1) Suitable for decorative applications and are UL listed for corrosion resistance.  
 (2) Also available with coated waterways without glass bulbs.

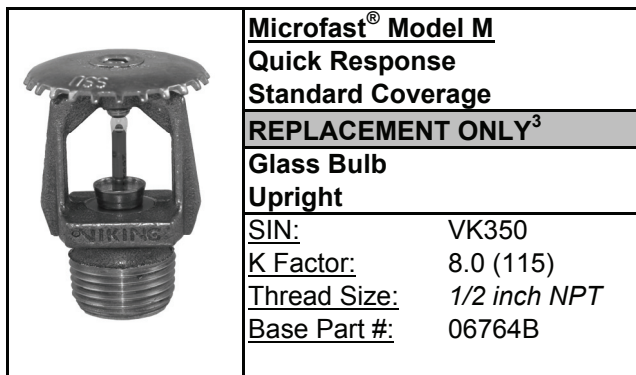

**Microfast® Model M**  
**Quick Response**  
**Standard Coverage**  
**REPLACEMENT ONLY<sup>3</sup>**  
**Glass Bulb**  
**Upright**  
**SIN:** VK350  
**K Factor:** 8.0 (115)  
**Thread Size:** 1/2 inch NPT  
**Base Part #:** 06764B

| Finish                               | Temp  | Part #     | IPG | List Price |
|--------------------------------------|-------|------------|-----|------------|
| Standard Brass                       | 155°F | 06764BAB   | V20 | \$39.90    |
| Standard Brass                       | 175°F | 06764BAD   | V20 | \$39.90    |
| Standard Brass                       | 200°F | 06764BAE   | V20 | \$39.90    |
| Standard Brass                       | 286°F | 06764BAG   | V20 | \$39.90    |
| Chrome                               | 155°F | 06764BFB   | V20 | \$43.49    |
| Chrome                               | 175°F | 06764BFD   | V20 | \$43.49    |
| Chrome                               | 200°F | 06764BFE   | V20 | \$43.49    |
| Chrome                               | 286°F | 06764BFG   | V20 | \$43.49    |
| White-Polyester <sup>1</sup>         | 155°F | 06764BMB/W | V20 | \$43.49    |
| White-Polyester                      | 175°F | 06764BMD/W | V20 | \$43.49    |
| White-Polyester                      | 200°F | 06764BME/W | V20 | \$43.49    |
| White-Polyester                      | 286°F | 06764BMG/W | V20 | \$43.49    |
| Black-Polyester <sup>1</sup>         | 155°F | 06764BMB/B | V20 | \$43.49    |
| Black-Polyester                      | 175°F | 06764BMD/B | V20 | \$43.49    |
| Black-Polyester                      | 200°F | 06764BME/B | V20 | \$43.49    |
| Black-Polyester                      | 286°F | 06764BMG/B | V20 | \$43.49    |
| Black (flouropolymer) <sup>1,2</sup> | 155°F | 06764BNB   | V20 | \$53.82    |
| Black (flouropolymer) <sup>1,2</sup> | 175°F | 06764BND   | V20 | \$53.82    |
| Black (flouropolymer) <sup>1,2</sup> | 200°F | 06764BNE   | V20 | \$53.82    |
| Black (flouropolymer) <sup>1,2</sup> | 286°F | 06764BNG   | V20 | \$53.82    |
| Std Sprinkler Wrench                 |       | 10896W/B   | V20 | \$56.27    |

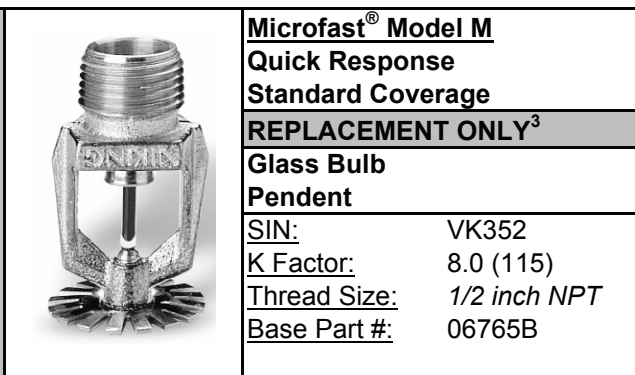

**Microfast® Model M**  
**Quick Response**  
**Standard Coverage**  
**REPLACEMENT ONLY<sup>3</sup>**  
**Glass Bulb**  
**Pendent**  
**SIN:** VK352  
**K Factor:** 8.0 (115)  
**Thread Size:** 1/2 inch NPT  
**Base Part #:** 06765B

| Finish                               | Temp  | Part #     | IPG | List Price |
|--------------------------------------|-------|------------|-----|------------|
| Standard Brass                       | 155°F | 06765BAB   | V20 | \$39.90    |
| Standard Brass                       | 175°F | 06765BAD   | V20 | \$39.90    |
| Standard Brass                       | 200°F | 06765BAE   | V20 | \$39.90    |
| Standard Brass                       | 286°F | 06765BAG   | V20 | \$39.90    |
| Chrome                               | 155°F | 06765BFB   | V20 | \$43.49    |
| Chrome                               | 175°F | 06765BFD   | V20 | \$43.49    |
| Chrome                               | 200°F | 06765BFE   | V20 | \$43.49    |
| Chrome                               | 286°F | 06765BFG   | V20 | \$43.49    |
| White-Polyester <sup>1</sup>         | 155°F | 06765BMB/W | V20 | \$43.49    |
| White-Polyester                      | 175°F | 06765BMD/W | V20 | \$43.49    |
| White-Polyester                      | 200°F | 06765BME/W | V20 | \$43.49    |
| White-Polyester                      | 286°F | 06765BMG/W | V20 | \$43.49    |
| Black-Polyester <sup>1</sup>         | 155°F | 06765BMB/B | V20 | \$43.49    |
| Black-Polyester                      | 175°F | 06765BMD/B | V20 | \$43.49    |
| Black-Polyester                      | 200°F | 06765BME/B | V20 | \$43.49    |
| Black-Polyester                      | 286°F | 06765BMG/B | V20 | \$43.49    |
| Black (flouropolymer) <sup>1,2</sup> | 155°F | 06765BNB   | V20 | \$53.82    |
| Black (flouropolymer) <sup>1,2</sup> | 175°F | 06765BND   | V20 | \$53.82    |
| Black (flouropolymer) <sup>1,2</sup> | 200°F | 06765BNE   | V20 | \$53.82    |
| Black (flouropolymer) <sup>1,2</sup> | 286°F | 06765BNG   | V20 | \$53.82    |
| Std Sprinkler Wrench                 |       | 10896W/B   | V20 | \$56.27    |
| Wrench for Rcsd w/Caps               |       | 16036W/B   | V20 | \$115.04   |

- (1) Suitable for decorative applications and are UL listed for corrosion resistance.
- (2) Also available with coated waterways without glass bulbs.
- (3) Replacement only - Not allowed in new installations.

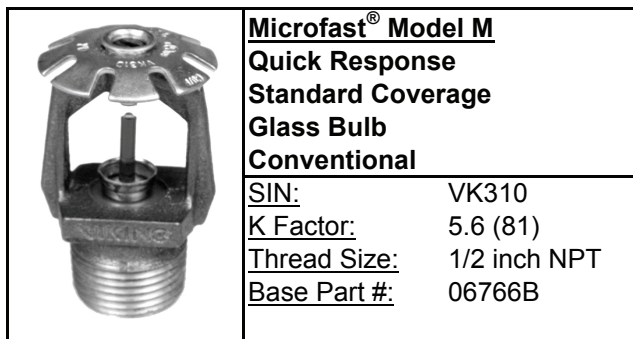

**Microfast® Model M**  
**Quick Response**  
**Standard Coverage**  
**Glass Bulb**  
**Conventional**  
SIN: VK310  
K Factor: 5.6 (81)  
Thread Size: 1/2 inch NPT  
Base Part #: 06766B

| Finish                               | Temp  | Part #     | IPG   | List Price |
|--------------------------------------|-------|------------|-------|------------|
| Standard Brass                       | 155°F | 06766BAB   | V13   | \$36.12    |
| Standard Brass                       | 175°F | 06766BAD   | V13   | \$36.12    |
| Standard Brass                       | 200°F | 06766BAE   | V13   | \$36.12    |
| Standard Brass                       | 286°F | 06766BAG   | V13   | \$36.12    |
| Chrome                               | 155°F | 06766BFB   | V13.1 | \$39.07    |
| Chrome                               | 175°F | 06766BFD   | V13.1 | \$39.07    |
| Chrome                               | 200°F | 06766BFE   | V13.1 | \$39.07    |
| Chrome                               | 286°F | 06766BFG   | V13.1 | \$39.07    |
| White-Polyester <sup>1</sup>         | 155°F | 06766BMB/W | V13.2 | \$39.07    |
| White-Polyester                      | 175°F | 06766BMD/W | V13.2 | \$39.07    |
| White-Polyester                      | 200°F | 06766BME/W | V13.2 | \$39.07    |
| White-Polyester                      | 286°F | 06766BMG/W | V13.2 | \$39.07    |
| Black-Polyester <sup>1</sup>         | 155°F | 06766BMB/B | V20   | \$40.60    |
| Black-Polyester                      | 175°F | 06766BMD/B | V20   | \$40.60    |
| Black-Polyester                      | 200°F | 06766BME/B | V20   | \$40.60    |
| Black-Polyester                      | 286°F | 06766BMG/B | V20   | \$40.60    |
| Black (flouropolymer) <sup>1,2</sup> | 155°F | 06766BNB   | V20   | \$52.36    |
| Black (flouropolymer) <sup>1,2</sup> | 175°F | 06766BND   | V20   | \$52.36    |
| Black (flouropolymer) <sup>1,2</sup> | 200°F | 06766BNE   | V20   | \$52.36    |
| Black (flouropolymer) <sup>1,2</sup> | 286°F | 06766BNG   | V20   | \$52.36    |
| Std Sprinkler Wrench                 |       | 10896W/B   | V20   | \$56.27    |

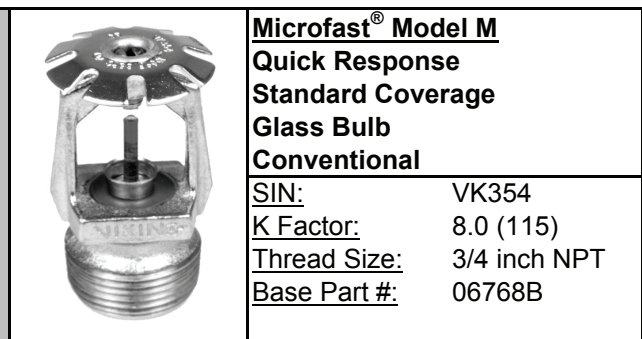

**Microfast® Model M**  
**Quick Response**  
**Standard Coverage**  
**Glass Bulb**  
**Conventional**  
SIN: VK354  
K Factor: 8.0 (115)  
Thread Size: 3/4 inch NPT  
Base Part #: 06768B

| Finish                               | Temp  | Part #     | IPG | List Price |
|--------------------------------------|-------|------------|-----|------------|
| Standard Brass                       | 155°F | 06768BAB   | V14 | \$38.73    |
| Standard Brass                       | 175°F | 06768BAD   | V14 | \$38.73    |
| Standard Brass                       | 200°F | 06768BAE   | V14 | \$38.73    |
| Standard Brass                       | 286°F | 06768BAG   | V14 | \$38.73    |
| Chrome                               | 155°F | 06768BFB   | V14 | \$42.15    |
| Chrome                               | 175°F | 06768BFD   | V14 | \$42.15    |
| Chrome                               | 200°F | 06768BFE   | V14 | \$42.15    |
| Chrome                               | 286°F | 06768BFG   | V14 | \$42.15    |
| White-Polyester <sup>1</sup>         | 155°F | 06768BMB/W | V14 | \$42.15    |
| White-Polyester                      | 175°F | 06768BMD/W | V14 | \$42.15    |
| White-Polyester                      | 200°F | 06768BME/W | V14 | \$42.15    |
| White-Polyester                      | 286°F | 06768BMG/W | V14 | \$42.15    |
| Black-Polyester <sup>1</sup>         | 155°F | 06768BMB/B | V20 | \$43.79    |
| Black-Polyester                      | 175°F | 06768BMD/B | V20 | \$43.79    |
| Black-Polyester                      | 200°F | 06768BME/B | V20 | \$43.79    |
| Black-Polyester                      | 286°F | 06768BMG/B | V20 | \$43.79    |
| Black (flouropolymer) <sup>1,2</sup> | 155°F | 06768BNB   | V20 | \$55.85    |
| Black (flouropolymer) <sup>1,2</sup> | 175°F | 06768BND   | V20 | \$55.85    |
| Black (flouropolymer) <sup>1,2</sup> | 200°F | 06768BNE   | V20 | \$55.85    |
| Black (flouropolymer) <sup>1,2</sup> | 286°F | 06768BNG   | V20 | \$55.85    |
| Std Sprinkler Wrench                 |       | 10896W/B   | V20 | \$56.27    |

(1) Suitable for decorative applications and are UL listed for corrosion resistance.  
(2) Also available with coated waterways without glass bulbs.

|  | <b>Microfast® Model M</b>  |              |     |            |
|---|--|--------------|-----|------------|
|   | <b>Quick Response<br/>Standard Coverage<br/>Glass Bulb<br/>Horizontal Sidewall</b> |              |     |            |
|   | <b>SIN:</b>  | VK333        |     |            |
|   | <b>K Factor:</b>   | 2.8 (40)     |     |            |
|   | <b>Thread Size:</b>  | 1/2 inch NPT |     |            |
|   | <b>Base Part #:</b>  | 10035        |     |            |
| Finish  | Temp   | Part #       | IPG | List Price |
| Standard Brass  | 155°F  | 10035AB      | V20 | \$45.33    |
| Standard Brass  | 175°F  | 10035AD      | V20 | \$45.33    |
| Standard Brass  | 200°F  | 10035AE      | V20 | \$45.33    |
| Standard Brass  | 286°F  | 10035AG      | V20 | \$45.33    |
| Chrome  | 155°F  | 10035FB      | V20 | \$48.07    |
| Chrome  | 175°F  | 10035FD      | V20 | \$48.07    |
| Chrome  | 200°F  | 10035FE      | V20 | \$48.07    |
| Chrome  | 286°F  | 10035FG      | V20 | \$48.07    |
| White-Polyester <sup>1</sup>  | 155°F  | 10035MB/W    | V20 | \$48.07    |
| White-Polyester   | 175°F  | 10035MD/W    | V20 | \$48.07    |
| White-Polyester   | 200°F  | 10035ME/W    | V20 | \$48.07    |
| White-Polyester   | 286°F  | 10035MG/W    | V20 | \$48.07    |
| Black-Polyester <sup>1</sup>  | 155°F  | 10035MB/B    | V20 | \$48.07    |
| Black-Polyester   | 175°F  | 10035MD/B    | V20 | \$48.07    |
| Black-Polyester   | 200°F  | 10035ME/B    | V20 | \$48.07    |
| Black-Polyester   | 286°F  | 10035MG/B    | V20 | \$48.07    |
| Black (flouropolymer) <sup>1,2</sup>  | 155°F  | 10035NB      | V20 | \$62.93    |
| Black (flouropolymer) <sup>1,2</sup>  | 175°F  | 10035ND      | V20 | \$62.93    |
| Black (flouropolymer) <sup>1,2</sup>  | 200°F  | 10035NE      | V20 | \$62.93    |
| Black (flouropolymer) <sup>1,2</sup>  | 286°F  | 10035NG      | V20 | \$62.93    |
| Std Sprinkler Wrench  |  | 10896W/B     | V20 | \$56.27    |
| Wrench for Rcsd w/Shld  |  | 13655W/B     | V20 | \$118.26   |

- (1) Suitable for decorative applications and are UL listed for corrosion resistance.  
(2) Also available with coated waterways without glass bulbs.



|  | <b>Microfast® Model M<br/>Quick Response<br/>Standard Coverage<br/>Glass Bulb<br/>Horizontal Sidewall</b> |                    |       |            |
|---|---|--------------------|-------|------------|
|   | <b>SIN:</b>   | VK305 <sup>1</sup> |       |            |
|   | <b>K Factor:</b>  | 5.6 (81)           |       |            |
|   | <b>Thread Size:</b>   | 1/2 inch NPT       |       |            |
|   | <b>Base Part #:</b>   | 12121              |       |            |
| Finish  | Temp  | Part #             | IPG   | List Price |
| Standard Brass  | 155°F   | 12121AB            | V13   | \$40.04    |
| Standard Brass  | 175°F   | 12121AD            | V13   | \$40.04    |
| Standard Brass  | 200°F   | 12121AE            | V13   | \$40.04    |
| Standard Brass  | 286°F   | 12121AG            | V13   | \$40.04    |
| Chrome  | 155°F   | 12121FB            | V13.1 | \$43.07    |
| Chrome  | 175°F   | 12121FD            | V13.1 | \$43.07    |
| Chrome  | 200°F   | 12121FE            | V13.1 | \$43.07    |
| Chrome  | 286°F   | 12121FG            | V13.1 | \$43.07    |
| White-Polyester <sup>3</sup>  | 155°F   | 12121MB/W          | V13.2 | \$43.07    |
| White-Polyester   | 175°F   | 12121MD/W          | V13.2 | \$43.07    |
| White-Polyester   | 200°F   | 12121ME/W          | V13.2 | \$43.07    |
| White-Polyester   | 286°F   | 12121MG/W          | V13.2 | \$43.07    |
| Black-Polyester <sup>3</sup>  | 155°F   | 12121MB/B          | V20   | \$44.73    |
| Black-Polyester   | 175°F   | 12121MD/B          | V20   | \$44.73    |
| Black-Polyester   | 200°F   | 12121ME/B          | V20   | \$44.73    |
| Black-Polyester   | 286°F   | 12121MG/B          | V20   | \$44.73    |
| Black (fluoropolymer) <sup>3,4</sup>  | 155°F   | 12121NB            | V20   | \$55.06    |
| Black (fluoropolymer)   | 175°F   | 12121ND            | V20   | \$55.06    |
| Black (fluoropolymer)   | 200°F   | 12121NE            | V20   | \$55.06    |
| Black (fluoropolymer)   | 286°F   | 12121NG            | V20   | \$55.06    |
| Std Sprinkler Wrench  |   | 10896W/B           | V20   | \$56.27    |
| Wrench for Rcsd w/Shld  |   | 13655W/B           | V20   | \$118.26   |

|  | <b>Microfast® Model M<br/>Quick Response<br/>Standard Coverage<br/>Glass Bulb<br/>Horizontal Sidewall</b> |                    |       |            |
|--|---|--------------------|-------|------------|
|  | <b>SIN:</b>   | VK360 <sup>1</sup> |       |            |
|  | <b>K Factor:</b>  | 8.0 (115)          |       |            |
|  | <b>Thread Size:</b>   | 3/4 inch NPT       |       |            |
|  | <b>Base Part #:</b>   | 15591              |       |            |
| Finish   | Temp  | Part #             | IPG   | List Price |
| Standard Brass   | 135°F   | 15591AA            | V20.2 | \$32.99    |
| Standard Brass   | 155°F   | 15591AB            | V20.2 | \$32.99    |
| Standard Brass   | 175°F   | 15591AD            | V20.2 | \$32.99    |
| Standard Brass   | 200°F   | 15591AE            | V20.2 | \$32.99    |
| Chrome   | 135°F   | 15591FA            | V20.2 | \$37.95    |
| Chrome   | 155°F   | 15591FB            | V20.2 | \$37.95    |
| Chrome   | 175°F   | 15591FD            | V20.2 | \$37.95    |
| Chrome   | 200°F   | 15591FE            | V20.2 | \$37.95    |
| White-Polyester <sup>3</sup>   | 135°F   | 15591MA/W          | V20.2 | \$37.95    |
| White-Polyester  | 155°F   | 15591MB/W          | V20.2 | \$37.95    |
| White-Polyester  | 175°F   | 15591MD/W          | V20.2 | \$37.95    |
| White-Polyester  | 200°F   | 15591ME/W          | V20.2 | \$37.95    |
| Black-Polyester <sup>3</sup>   | 135°F   | 15591MA/B          | V20.2 | \$37.95    |
| Black-Polyester  | 155°F   | 15591MB/B          | V20.2 | \$37.95    |
| Black-Polyester  | 175°F   | 15591MD/B          | V20.2 | \$37.95    |
| Black-Polyester  | 200°F   | 15591ME/B          | V20.2 | \$37.95    |
| Black (fluoropolymer) <sup>3,4</sup>   | 135°F   | 15591NA            | V20.2 | POA        |
| Black (fluoropolymer)  | 155°F   | 15591NB            | V20.2 | POA        |
| Black (fluoropolymer)  | 175°F   | 15591ND            | V20.2 | POA        |
| Black (fluoropolymer)  | 200°F   | 15591NE            | V20.2 | POA        |
| Std Sprinkler Wrench   |   | 10896W/B           | V20   | \$56.27    |
| Wrench for Rcsd w/Shld   |   | 13655W/B           | V20   | \$118.26   |

|   |   |                    |  |  |
|---|---|--------------------|--|--|
|  | <b>Microfast® Model M<br/>Quick Response<br/>Standard Coverage<br/>Glass Bulb<br/>Vertical Sidewall</b> |                    |  |  |
|   | <b>SIN:</b>   | VK306 <sup>2</sup> |  |  |
|   | <b>K Factor:</b>  | 5.6 (81)           |  |  |
|   | <b>Thread Size:</b>   | 1/2 inch NPT       |  |  |
|   | <b>Base Part #:</b>   | 06727B             |  |  |

| Finish                               | Temp  | Part #     | IPG | List Price |
|--------------------------------------|-------|------------|-----|------------|
| Standard Brass                       | 155°F | 06727BAB   | V20 | \$42.55    |
| Standard Brass                       | 175°F | 06727BAD   | V20 | \$42.55    |
| Standard Brass                       | 200°F | 06727BAE   | V20 | \$42.55    |
| Standard Brass                       | 286°F | 06727BAG   | V20 | \$42.55    |
| Chrome                               | 155°F | 06727BFB   | V20 | \$46.35    |
| Chrome                               | 175°F | 06727BFD   | V20 | \$46.35    |
| Chrome                               | 200°F | 06727BFE   | V20 | \$46.35    |
| Chrome                               | 286°F | 06727BFG   | V20 | \$46.35    |
| White-Polyester <sup>3</sup>         | 155°F | 06727BMB/W | V20 | \$46.35    |
| White-Polyester                      | 175°F | 06727BMD/W | V20 | \$46.35    |
| White-Polyester                      | 200°F | 06727BME/W | V20 | \$46.35    |
| White-Polyester                      | 286°F | 06727BMG/W | V20 | \$46.35    |
| Black-Polyester <sup>3</sup>         | 155°F | 06727BMB/B | V20 | \$46.35    |
| Black-Polyester                      | 175°F | 06727BMD/B | V20 | \$46.35    |
| Black-Polyester                      | 200°F | 06727BME/B | V20 | \$46.35    |
| Black-Polyester                      | 286°F | 06727BMG/B | V20 | \$46.35    |
| Black (fluoropolymer) <sup>3,4</sup> | 155°F | 06727BNB   | V20 | \$57.05    |
| Black (fluoropolymer)                | 175°F | 06727BND   | V20 | \$57.05    |
| Black (fluoropolymer)                | 200°F | 06727BNE   | V20 | \$57.05    |
| Black (fluoropolymer)                | 286°F | 06727BNG   | V20 | \$57.05    |
| Std Sprinkler Wrench                 |       | 10896W/B   | V20 | \$56.27    |

- (1) Light/Ordinary hazard
- (2) Light hazard only
- (3) Suitable for decorative applications and are UL listed for corrosion resistance.
- (4) Also available with coated waterways without glass bulbs

|  | <b>Domed Concealed<sup>1</sup></b> |           |       |            |
|---|------------------------------------|-----------|-------|------------|
|   | <b>Quick Response<sup>2</sup></b>  |           |       |            |
| <b>Standard Coverage</b>  |                                    |           |       |            |
| <b>Glass Bulb</b>   |                                    |           |       |            |
| <b>Pendant</b>  |                                    |           |       |            |
| <b>SIN:</b>   | VK302-D                            |           |       |            |
| <b>K Factor:</b>  | 5.6 (81)                           |           |       |            |
| <b>Thread Size:</b>   | 1/2 inch NPT                       |           |       |            |
| <b>Base Part #:</b>   | 06662BA-X                          |           |       |            |
| Finish  | Temp                               | Part #    | IPG   | List Price |
| Standard Brass  | 155°F                              | 06662BABX | V15.4 | \$35.34    |
| Standard Brass  | 175°F                              | 06662BADX | V15.4 | \$35.34    |
| Standard Brass  | 200°F                              | 06662BAEX | V15.4 | \$35.34    |
| Spk Wrench Domed Cncd   | 13577W/B                           | V20       |       | \$104.58   |

|  | <b>Domed Concealed<sup>1</sup></b> |           |       |            |
|--|------------------------------------|-----------|-------|------------|
|  | <b>Quick Response<sup>2</sup></b>  |           |       |            |
| <b>Standard Coverage</b>   |                                    |           |       |            |
| <b>Glass Bulb</b>  |                                    |           |       |            |
| <b>Pendant</b>   |                                    |           |       |            |
| <b>SIN:</b>  | VK352-D                            |           |       |            |
| <b>K Factor:</b>   | 8.0 (115)                          |           |       |            |
| <b>Thread Size:</b>  | 3/4 inch NPT                       |           |       |            |
| <b>Base Part #:</b>  | 06666BA-X                          |           |       |            |
| Finish   | Temp                               | Part #    | IPG   | List Price |
| Standard Brass   | 155°F                              | 06666BABX | V15.4 | \$49.71    |
| Standard Brass   | 175°F                              | 06666BADX | V15.4 | \$49.71    |
| Standard Brass   | 200°F                              | 06666BAEX | V15.4 | \$49.71    |
| Spk Wrench Domed Cncd  | 13577W/B                           | V20       |       | \$104.58   |

| <b>Domed Cover Plate<sup>1</sup></b> |       |           |       |            |  |
|--------------------------------------|-------|-----------|-------|------------|---|
| <b>Base Part #:</b> 12381            |       |           |       |            |   |
| Finish                               | Temp  | Part #    | IPG   | List Price |   |
| Chrome                               | 135°F | 12381FA   | V15.3 | \$26.11    |   |
| Chrome                               | 165°F | 12381FC   | V15.3 | \$26.11    |   |
| Painted White                        | 135°F | 12381MA/W | V15.3 | \$26.11    |   |
| Painted White                        | 165°F | 12381MC/W | V15.3 | \$26.11    |   |
| Painted Ivory                        | 135°F | 12381MA/I | V15.3 | \$32.73    |   |
| Painted Ivory                        | 165°F | 12381MC/I | V15.3 | \$32.73    |   |
| Painted Black                        | 135°F | 12381MA/B | V15.3 | \$32.73    |   |
| Painted Black                        | 165°F | 12381MC/B | V15.3 | \$32.93    |   |
| Bright Brass                         | 135°F | 12381BA/B | V15.3 | \$32.73    |   |
| Bright Brass                         | 165°F | 12381BC/B | V15.3 | \$32.73    |   |

|  | <b>Horizon® Flush (Model H-1)<sup>2</sup></b> |            |     |            |
|---|---|------------|-----|------------|
|   | <b>Quick Response</b>                         |            |     |            |
| <b>Standard Coverage</b>  |   |            |     |            |
| <b>Fusible Link</b>   |   |            |     |            |
| <b>Flush Pendant</b>  |   |            |     |            |
| <b>SIN:</b>   | VK402   |            |     |            |
| <b>K Factor:</b>  | 5.6 (81)                                      |            |     |            |
| <b>Thread Size:</b>   | 1/2 inch NPT                                  |            |     |            |
| <b>Base Part #:</b>   | 06702B  |            |     |            |
| Finish  | Temp  | Part #     | IPG | List Price |
| Chrome  | 165°F   | 06702BFC   | V17 | \$60.55    |
| Painted White   | 165°F   | 06702BMC/W | V17 | \$61.57    |
| Heavy Duty Spk Wrench   | 08336W/B                                      | V20        |     | \$108.36   |
| Light Duty Spk Wrench   | 10366W/B                                      | V20        |     | \$25.65    |

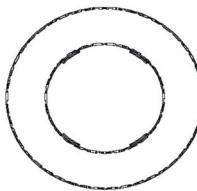
| <b>Ceiling Rings<sup>2</sup></b>  |        |           |     |            |
|---|--------|-----------|-----|------------|
|  |        |           |     |            |
| <b>Outside Diameter = 2-11/16 inches</b>  |        |           |     |            |
| Finish  | Type   | Part #    | IPG | List Price |
| Chrome  | Push   | 07027F    | V17 | \$6.05     |
| Chrome  | Thread | 06919BF   | V17 | \$6.20     |
| Painted White   | Push   | 07027M/W  | V17 | \$6.37     |
| Painted White   | Thread | 06919BM/W | V17 | \$6.49     |
| <b>Outside Diameter = 3 in. (push on), 3-1/4 in. (thread on)</b>                      |        |           |     |            |
| Finish  | Type   | Part #    | IPG | List Price |
| Chrome  | Push   | 07626F    | V17 | \$6.20     |
| Chrome  | Thread | 06905BF   | V17 | \$10.52    |
| Painted White   | Push   | 07626M/W  | V17 | \$6.49     |
| Painted White   | Thread | 06905BM/W | V17 | \$10.80    |

(1) Cover plates sold separately. Covers are also available in custom colors at an additional charge (see page F-7 for details).

(2) FM Approved as standard response. Refer to technical data page for complete listing and approval details.

(3) Ceiling rings for Horizon flush pendant sprinklers are sold separately.

|   |  |               |            |                   |
|---|--|---------------|------------|-------------------|
|  | <b>Mirage®</b>   |               |            |                   |
|   | <b>Quick Response<br/>Standard Coverage<br/>Glass Bulb<br/>Concealed Pendant</b> |               |            |                   |
|   | <u>SIN:</u>  | VK461         |            |                   |
|   | <u>K Factor:</u>   | 2.8 (40)      |            |                   |
|   | <u>Thread Size:</u>  | 1/2 inch NPT  |            |                   |
|   | <u>Base Part #:</u>  | 13831A        |            |                   |
| <b>Finish</b>   | <b>Temp</b>  | <b>Part #</b> | <b>IPG</b> | <b>List Price</b> |
| Standard Brass  | 155°F  | 13831AB       | V16.4      | \$50.00           |
| Standard Brass  | 175°F  | 13831AD       | V16.4      | \$50.00           |
| Standard Brass  | 200°F  | 13831AE       | V16.4      | \$50.00           |

|  |  |               |            |                   |
|--|--|---------------|------------|-------------------|
|  | <b>Mirage®</b>   |               |            |                   |
|  | <b>Quick Response<br/>Standard Coverage<br/>Glass Bulb<br/>Concealed Pendant</b> |               |            |                   |
|  | <u>SIN:</u>  | VK465         |            |                   |
|  | <u>K Factor:</u>   | 4.2 (60)      |            |                   |
|  | <u>Thread Size:</u>  | 1/2 inch NPT  |            |                   |
|  | <u>Base Part #:</u>  | 14262A        |            |                   |
| <b>Finish</b>  | <b>Temp</b>  | <b>Part #</b> | <b>IPG</b> | <b>List Price</b> |
| Standard Brass   | 155°F  | 14262AB       | V16.4      | \$50.00           |
| Standard Brass   | 175°F  | 14262AD       | V16.4      | \$50.00           |
| Standard Brass   | 200°F  | 14262AE       | V16.4      | \$50.00           |

**COVER PLATES AND WRENCHES ARE SOLD SEPARATELY - SEE PAGE B-11 AND B-12 FOR DETAILS**

|   |  |               |            |                   |
|---|--|---------------|------------|-------------------|
|  | <b>Mirage®</b>   |               |            |                   |
|   | <b>Quick Response<br/>Standard Coverage<br/>Glass Bulb<br/>Concealed Pendant</b> |               |            |                   |
|   | <u>SIN:</u>  | VK462         |            |                   |
|   | <u>K Factor:</u>   | 5.6 (81)      |            |                   |
|   | <u>Thread Size:</u>  | 1/2 inch NPT  |            |                   |
|   | <u>Base Part #:</u>  | 13503A        |            |                   |
| <b>Finish</b>   | <b>Temp</b>  | <b>Part #</b> | <b>IPG</b> | <b>List Price</b> |
| Standard Brass  | 155°F  | 13503AB       | V16.4      | \$40.31           |
| Standard Brass  | 175°F  | 13503AD       | V16.4      | \$40.31           |
| Standard Brass  | 200°F  | 13503AE       | V16.4      | \$40.31           |

|  |  |                      |            |                   |
|--|--|----------------------|------------|-------------------|
|  | <b>Mirage® - HIGH PRESSURE</b>   |                      |            |                   |
|  | <b>Quick Response<br/>Standard Coverage<br/>Glass Bulb<br/>Concealed Pendant</b> |                      |            |                   |
|  | <u>SIN:</u>  | VK463                |            |                   |
|  | <u>K Factor:</u>   | 5.6 (81) - <b>HP</b> |            |                   |
|  | <u>Thread Size:</u>  | 1/2 inch NPT         |            |                   |
|  | <u>Base Part #:</u>  | 13667A               |            |                   |
| <b>Finish</b>  | <b>Temp</b>  | <b>Part #</b>        | <b>IPG</b> | <b>List Price</b> |
| Standard Brass   | 155°F  | 13667AB              | V16.4      | \$46.32           |
| Standard Brass   | 175°F  | 13667AD              | V16.4      | \$46.32           |
| Standard Brass   | 200°F  | 13667AE              | V16.4      | \$46.32           |

**COVER PLATES AND WRENCHES ARE SOLD SEPARATELY - SEE PAGE B-11 AND B-12 FOR DETAILS**

|   |  |               |            |                   |
|---|--|---------------|------------|-------------------|
|  | <b>Mirage®</b>   |               |            |                   |
|   | <b>Quick Response<br/>Standard Coverage<br/>Glass Bulb<br/>Concealed Pendant</b> |               |            |                   |
|   | <u>SIN:</u>  | VK464         |            |                   |
|   | <u>K Factor:</u>   | 8.0 (115)     |            |                   |
|   | <u>Thread Size:</u>  | 3/4 inch NPT  |            |                   |
|   | <u>Base Part #:</u>  | 13614A        |            |                   |
| <b>Finish</b>   | <b>Temp</b>  | <b>Part #</b> | <b>IPG</b> | <b>List Price</b> |
| Standard Brass  | 155°F  | 13614AB       | V16.4      | \$59.17           |
| Standard Brass  | 175°F  | 13614AD       | V16.4      | \$59.17           |
| Standard Brass  | 200°F  | 13614AE       | V16.4      | \$59.17           |

|  |  |               |            |                   |
|--|--|---------------|------------|-------------------|
|  | <b>ELO Mirage®<sup>1</sup></b>   |               |            |                   |
|  | <b>Quick Response<br/>Standard Coverage<br/>Fusible Link<br/>Concealed Pendant</b> |               |            |                   |
|  | <u>SIN:</u>  | VK469         |            |                   |
|  | <u>K Factor:</u>   | 11.2 (161)    |            |                   |
|  | <u>Thread Size:</u>  | 3/4 inch NPT  |            |                   |
|  | <u>Base Part #:</u>  | 15764A        |            |                   |
| <b>Finish</b>  | <b>Temp</b>  | <b>Part #</b> | <b>IPG</b> | <b>List Price</b> |
| Standard Brass   | 165°F  | 15764AC       | V16.4      | \$58.83           |
| Standard Brass   | 205°F  | 15764AE       | V16.4      | \$58.83           |

(1) Use only cover plate 15765 with VK469 (see page C-11)

**COVER PLATES AND WRENCHES ARE SOLD SEPARATELY - SEE PAGE B-11 AND B-12 FOR DETAILS**

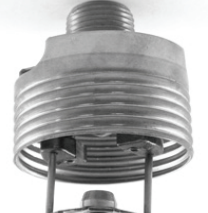
|   |  |               |            |                   |
|---|--|---------------|------------|-------------------|
|  | <b>Mirage MRI Room Sprinkler*</b>  |               |            |                   |
|   | <b>Quick Response<br/>Standard Coverage<br/>Glass Bulb<br/>Concealed Pendant</b> |               |            |                   |
|   | <u>SIN:</u>  | VK462-MRI     |            |                   |
|   | <u>K Factor:</u>   | 5.6 (81)      |            |                   |
|   | <u>Thread Size:</u>  | 1/2 inch NPT  |            |                   |
|   | <u>Base Part #:</u>  | 15480A        |            |                   |
| <b>Finish</b>   | <b>Temp</b>  | <b>Part #</b> | <b>IPG</b> | <b>List Price</b> |
| Standard Brass  | 155°F  | 15480AB       | V16.4      | \$124.52          |
| Standard Brass  | 175°F  | 15480AD       | V16.4      | \$124.52          |
| Standard Brass  | 200°F  | 15480AE       | V16.4      | \$124.52          |

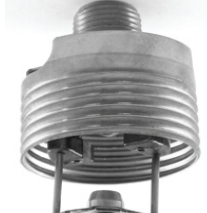
|  |  |               |            |                   |
|--|--|---------------|------------|-------------------|
|  | <b>Mirage MRI Room Sprinkler*</b>  |               |            |                   |
|  | <b>Quick Response<br/>Standard Coverage<br/>Glass Bulb<br/>Concealed Pendant</b> |               |            |                   |
|  | <u>SIN:</u>  | VK464-MRI     |            |                   |
|  | <u>K Factor:</u>   | 8.0 (115)     |            |                   |
|  | <u>Thread Size:</u>  | 3/4 inch NPT  |            |                   |
|  | <u>Base Part #:</u>  | 15481A        |            |                   |
| <b>Finish</b>  | <b>Temp</b>  | <b>Part #</b> | <b>IPG</b> | <b>List Price</b> |
| Standard Brass   | 155°F  | 15481AB       | V16.4      | \$138.57          |
| Standard Brass   | 175°F  | 15481AD       | V16.4      | \$138.57          |
| Standard Brass   | 200°F  | 15481AE       | V16.4      | \$138.57          |

\* Non-ferrous - for use in a high magnetic field environment, such as an MRI room

**COVER PLATES AND WRENCHES ARE SOLD SEPARATELY - SEE PAGE B-11 AND B-12 FOR DETAILS**

| <b>Standard Cover Plate</b>             |       |           |       |         |
|---|-------|-----------|-------|---------|
| <i>Diameter = 2-3/4 inches</i>          |       |           |       |         |
| <i>Use w/ VK461, 462, 463, 464, 465</i> |       |           |       |         |
| Finish                                  | Temp  | Part #    | IPG   | List    |
| Polished Chrome                         | 135°F | 13504FA   | V16.2 | \$26.06 |
| Polished Chrome                         | 165°F | 13504FC   | V16.2 | \$26.06 |
| White                                   | 135°F | 13504MA/W | V16.2 | \$26.06 |
| White                                   | 165°F | 13504MC/W | V16.2 | \$26.06 |
| Ivory                                   | 135°F | 13504MA/I | V16.2 | \$32.61 |
| Ivory                                   | 165°F | 13504MC/I | V16.2 | \$32.61 |
| Black                                   | 135°F | 13504MA/B | V16.2 | \$32.61 |
| Black                                   | 165°F | 13504MC/B | V16.2 | \$32.61 |
| Bright Brass                            | 135°F | 13504BA   | V16.2 | \$32.61 |
| Bright Brass                            | 165°F | 13504BC   | V16.2 | \$32.61 |
| Brushed Brass                           | 135°F | 13504BA/B | V16.2 | \$32.61 |
| Brushed Brass                           | 165°F | 13504BC/B | V16.2 | \$32.61 |
| Antique Brass                           | 135°F | 13504BA/A | V16.2 | \$32.61 |
| Antique Brass                           | 165°F | 13504BC/A | V16.2 | \$32.61 |
| Brushed Copper                          | 135°F | 13504EA/B | V16.2 | \$32.61 |
| Brushed Copper                          | 165°F | 13504EC/B | V16.2 | \$32.61 |
| Brushed Chrome                          | 135°F | 13504FA/B | V16.2 | \$32.61 |
| Brushed Chrome                          | 165°F | 13504FC/B | V16.2 | \$32.61 |



| <b>Large Cover Plate</b>                |       |           |       |         |
|---|-------|-----------|-------|---------|
| <i>Diameter = 3-5/16 inches</i>         |       |           |       |         |
| <i>Use w/ VK461, 462, 463, 464, 465</i> |       |           |       |         |
| Finish                                  | Temp  | Part #    | IPG   | List    |
| Polished Chrome                         | 135°F | 13642FA   | V16.2 | \$26.06 |
| Polished Chrome                         | 165°F | 13642FC   | V16.2 | \$26.06 |
| White                                   | 135°F | 13642MA/W | V16.2 | \$26.06 |
| White                                   | 165°F | 13642MC/W | V16.2 | \$26.06 |
| Ivory                                   | 135°F | 13642MA/I | V16.2 | \$32.61 |
| Ivory                                   | 165°F | 13642MC/I | V16.2 | \$32.61 |
| Black                                   | 135°F | 13642MA/B | V16.2 | \$32.61 |
| Black                                   | 165°F | 13642MC/B | V16.2 | \$32.61 |
| Bright Brass                            | 135°F | 13642BA   | V16.2 | \$32.61 |
| Bright Brass                            | 165°F | 13642BC   | V16.2 | \$32.61 |
| Brushed Brass                           | 135°F | 13642BA/B | V16.2 | \$32.61 |
| Brushed Brass                           | 165°F | 13642BC/B | V16.2 | \$32.61 |
| Antique Brass                           | 135°F | 13642BA/A | V16.2 | \$32.61 |
| Antique Brass                           | 165°F | 13642BC/A | V16.2 | \$32.61 |
| Brushed Copper                          | 135°F | 13642EA/B | V16.2 | \$32.61 |
| Brushed Copper                          | 165°F | 13642EC/B | V16.2 | \$32.61 |
| Brushed Chrome                          | 135°F | 13642FA/B | V16.2 | \$32.61 |
| Brushed Chrome                          | 165°F | 13642FC/B | V16.2 | \$32.61 |



| <b>Square Cover Plate</b>               |       |           |       |         |
|---|-------|-----------|-------|---------|
| <i>Use w/ VK461, 462, 463, 464, 465</i> |       |           |       |         |
| Finish                                  | Temp  | Part #    | IPG   | List    |
| Polished Chrome                         | 135°F | 15394FA   | V16.5 | \$44.84 |
| Polished Chrome                         | 165°F | 15394FC   | V16.5 | \$44.84 |
| White                                   | 135°F | 15394MA/W | V16.5 | \$43.04 |
| White                                   | 165°F | 15394MC/W | V16.5 | \$43.04 |
| Ivory                                   | 135°F | 15394MA/I | V16.5 | \$43.04 |
| Ivory                                   | 165°F | 15394MC/I | V16.5 | \$43.04 |
| Black                                   | 135°F | 15394MA/B | V16.5 | \$43.04 |
| Black                                   | 165°F | 15394MC/B | V16.5 | \$43.04 |
| Bright Brass                            | 135°F | 15394BA   | V16.5 | \$52.49 |
| Bright Brass                            | 165°F | 15394BC   | V16.5 | \$52.49 |
| Brushed Brass                           | 135°F | 15394BA/B | V16.5 | \$52.49 |
| Brushed Brass                           | 165°F | 15394BC/B | V16.5 | \$52.49 |
| Antique Brass                           | 135°F | 15394BA/A | V16.5 | \$52.49 |
| Antique Brass                           | 165°F | 15394BC/A | V16.5 | \$52.49 |
| Brushed Copper                          | 135°F | 15394EA/B | V16.5 | \$52.49 |
| Brushed Copper                          | 165°F | 15394EC/B | V16.5 | \$52.49 |
| Brushed Chrome                          | 135°F | 15394FA/B | V16.5 | \$52.49 |
| Brushed Chrome                          | 165°F | 15394FC/B | V16.5 | \$52.49 |



| <b>Mirage ELO Cover Plate</b>        |       |           |       |         |
|--------------------------------------|-------|-----------|-------|---------|
| <i>Diameter = 3-5/16 inches</i>      |       |           |       |         |
| <i>* For use with VK469 ELO only</i> |       |           |       |         |
| Finish                               | Temp  | Part #    | IPG   | List    |
| Polished Chrome                      | 135°F | 15765FA   | V16.2 | \$26.06 |
| Polished Chrome                      | 165°F | 15765FC   | V16.2 | \$26.06 |
| White                                | 135°F | 15765MA/W | V16.2 | \$26.06 |
| White                                | 165°F | 15765MC/W | V16.2 | \$26.06 |
| Ivory                                | 135°F | 15765MA/I | V16.2 | \$32.61 |
| Ivory                                | 165°F | 15765MC/I | V16.2 | \$32.61 |
| Black                                | 135°F | 15765MA/B | V16.2 | \$32.61 |
| Black                                | 165°F | 15765MC/B | V16.2 | \$32.61 |



| <b>Cleanroom Cover Assembly</b>   |  |
|---|--|
| <i>Diameter = 3-5/16 inches</i>   |  |
| <i>cULus listed</i>   |  |
| <i>For use w/ VK461, 462, 463, 464, 465</i>   |  |
| <i>Gasket color is white</i>  |  |
| <ul style="list-style-type: none"> <li>• Provides seal for cleanroom and clean zone environments</li> <li>• VK462 retains QR listing with cleanroom cover plate installed</li> <li>• Cover plate available in 135°F and 165°F temperature rating</li> <li>• Also listed for use with Mirage-MRI room sprinkler (non-ferrous)</li> </ul> |  |



| Finish          | Temp  | Part #       | IPG   | List    |
|-----------------|-------|--------------|-------|---------|
| Polished Chrome | 135°F | 13642FA/CR   | V16.2 | \$67.87 |
| Polished Chrome | 165°F | 13642FC/CR   | V16.2 | \$67.87 |
| White           | 135°F | 13642MA/W/CR | V16.2 | \$67.87 |
| White           | 165°F | 13642MC/W/CR | V16.2 | \$67.87 |
| Ivory           | 135°F | 13642MA/I/CR | V16.2 | \$67.87 |
| Ivory           | 165°F | 13642MC/I/CR | V16.2 | \$67.87 |
| Black           | 135°F | 13642MA/B/CR | V16.2 | \$32.61 |
| Black           | 165°F | 13642MC/B/CR | V16.2 | \$67.87 |

|  |  |  |  |
|--|--|--|--|
|  | <b>Mirage® Adjustable Concealed Pendant</b><br><b>Quick Response</b><br><b>Standard Coverage</b><br><b>Glass Bulb</b><br><b>Adjustable Concealed Pendant</b> |  | Offers 1-1/2 inch (38 mm) of total vertical adjustment |
|  | S/Ns: VK461, VK465, VK462  |  |  |
|  | K Factors: 2.8 (40), 4.2 (61), and 5.6 (81)  |  |  |
|  | Thread Size: 1 inch NPT (male and female connections)  |  |  |

| Finish  | Connection | K factor | Temp  | Part #  | IPG   | List Price |
|---|------------|----------|-------|---------|-------|------------|
| <b>VK461, 2.8 (40) K factor, Adjustable Concealed Pendant</b> |            |          |       |         |       |            |
| Standard Brass  | Male       | 2.8 (40) | 155°F | 14927AB | V15.4 | \$151.35   |
| Standard Brass  | Male       | 2.8 (40) | 175°F | 14927AD | V15.4 | \$151.35   |
| Standard Brass  | Male       | 2.8 (40) | 200°F | 14927AE | V15.4 | \$151.35   |
| Standard Brass  | Female     | 2.8 (40) | 155°F | 14928AB | V15.4 | \$151.35   |
| Standard Brass  | Female     | 2.8 (40) | 175°F | 14928AD | V15.4 | \$151.35   |
| Standard Brass  | Female     | 2.8 (40) | 200°F | 14928AE | V15.4 | \$151.35   |
| <b>VK465, 4.2 (61) K factor, Adjustable Concealed Pendant</b> |            |          |       |         |       |            |
| Standard Brass  | Male       | 4.2 (61) | 155°F | 14929AB | V15.4 | \$151.35   |
| Standard Brass  | Male       | 4.2 (61) | 175°F | 14929AD | V15.4 | \$151.35   |
| Standard Brass  | Male       | 4.2 (61) | 200°F | 14929AE | V15.4 | \$151.35   |
| Standard Brass  | Female     | 4.2 (61) | 155°F | 14930AB | V15.4 | \$151.35   |
| Standard Brass  | Female     | 4.2 (61) | 175°F | 14930AD | V15.4 | \$151.35   |
| Standard Brass  | Female     | 4.2 (61) | 200°F | 14930AE | V15.4 | \$151.35   |
| <b>VK462, 5.6 (81) K factor, Adjustable Concealed Pendant</b> |            |          |       |         |       |            |
| Standard Brass  | Male       | 5.6 (81) | 155°F | 14918AB | V15.4 | \$151.35   |
| Standard Brass  | Male       | 5.6 (81) | 175°F | 14918AD | V15.4 | \$151.35   |
| Standard Brass  | Male       | 5.6 (81) | 200°F | 14918AE | V15.4 | \$151.35   |
| Standard Brass  | Female     | 5.6 (81) | 155°F | 14919AB | V15.4 | \$151.35   |
| Standard Brass  | Female     | 5.6 (81) | 175°F | 14919AD | V15.4 | \$151.35   |
| Standard Brass  | Female     | 5.6 (81) | 200°F | 14919AE | V15.4 | \$151.35   |

**COVER PLATES SOLD SEPARATELY - See page B-11 for available cover plate options**

**Mirage® Concealed Pendant Sprinklers - Wrenches and Special Installation Tools**

**Standard / Heavy Duty Wrench**  
 (use with all Mirage sprinklers except VK469 ELO)

| Part #   | List Price |
|----------|------------|
| 14047W/B | \$108.37   |

*\* item price group V20*

**VK469 - Standard / Heavy Duty Wrench**  
 (use only with VK469 Mirage ELO sprinkler)

| Part #   | List Price |
|----------|------------|
| 15467W/B | \$108.37   |

*\* item price group V20*

**Cabinet Wrench and Protective Cap Removal Tool**

|            | Standard | VK469 ELO |
|------------|----------|-----------|
| Part #     | 14031    | 15466     |
| List Price | \$22.21  | \$22.21   |

*\* item price group V20*

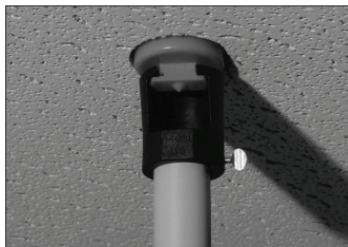

Figure 1: Attach Sprinkler Wrench 14031 onto a length of 1" diameter CPVC pipe



Figure 2: Use Sprinkler Wrench 14031 to remove the protective sprinkler cap.

**Cover Plate Installation Tool - Standard Dia. Cover Plates**

|            |        |
|------------|--------|
| Part #     | 14412  |
| List Price | \$9.81 |

*\* item price group V20*



Figure 3: Attach the Cover Installer Tool onto the end of CPVC pipe.



Figure 4: Use the Cover Installer Tool to install the Mirage® Concealed Cover Plate.



Figure 5: Correct use of the Cover Installer Tool

**Cover Plate Installation Tool - Large Dia. Cover Plates**

|            |        |
|------------|--------|
| Part #     | 14867  |
| List Price | \$9.81 |

*\* item price group V20*

|   |  |   |            |                   |
|---|--|---|------------|-------------------|
|  | <b>Quick Response<br/>Standard Coverage<br/>Fusible Link<br/>Concealed Sidewall</b>                              |   |            |                   |
|   | <b>SIN:</b> VK481<br><b>K Factor:</b> 5.6 (81)<br><b>Thread Size:</b> 1/2 inch NPT<br><b>Base Part #:</b> 17555A |   |            |                   |
| <b>Finish</b>   | <b>Temp</b>  | <b>Part #</b>   | <b>IPG</b> | <b>List Price</b> |
| Standard Brass  | 165°F  | 17555AC   | V16.3      | \$77.09           |
| Standard Brass  | 220°F  | 17555AF   | V16.3      | \$77.09           |
| Heavy Duty Spk Wrench   |  | 16208W/R  | V20        | \$74.50           |
| <i>cover plate sold separately (see below)</i>                                    |  |   |            |                   |
| <b>VK481 Cover Plate</b><br>Diameter = 3-5/16 inches                              |  |  |            |                   |
| <b>Finish</b>   | <b>Temp</b>  | <b>Part #</b>   | <b>IPG</b> | <b>List Price</b> |
| White   | 135°F  | 16207MA/W   | V16.3A     | \$26.06           |
| White   | 165°F  | 16207MC/W   | V16.3A     | \$26.06           |

(1) Cover plates sold separately. Covers are also available in custom colors at an additional charge (see pg. F-7)

|                             |       |           |       |            |
|--|-------|-----------|-------|------------|
| Microfast® Model M<br>Quick Response<br>Standard Coverage<br>FUSIBLE LINK <sup>1</sup><br>Upright Sprinklers |       |           |       |            |
| Finish   | Temp  | Part #    | IPG   | List Price |
| <b>VK326 - 2.8 (40) K Factor - 1/2 in NPT - UPRIGHT (QR)</b>   |       |           |       |            |
| Standard Brass   | 165°F | 13957AC   | V14.2 | \$48.14    |
| Standard Brass   | 205°F | 13957AE   | V14.2 | \$48.14    |
| Standard Brass   | 280°F | 13957AG   | V14.2 | \$48.14    |
| Chrome   | 165°F | 13957FC   | V14.2 | \$50.04    |
| Chrome   | 205°F | 13957FE   | V14.2 | \$50.04    |
| Chrome   | 280°F | 13957FG   | V14.2 | \$50.04    |
| White-Polyester  | 165°F | 13957MC/W | V14.2 | \$53.61    |
| White-Polyester  | 205°F | 13957ME/W | V14.2 | \$53.61    |
| White-Polyester  | 280°F | 13957MG/W | V14.2 | \$53.61    |
| <b>VK328 - 4.2 (60) K Factor - 1/2 in NPT - UPRIGHT (QR)</b>   |       |           |       |            |
| Standard Brass   | 165°F | 13958AC   | V20   | \$46.52    |
| Standard Brass   | 205°F | 13958AE   | V20   | \$46.52    |
| Standard Brass   | 280°F | 13958AG   | V20   | \$46.52    |
| Chrome   | 165°F | 13958FC   | V20   | \$49.91    |
| Chrome   | 205°F | 13958FE   | V20   | \$49.91    |
| Chrome   | 280°F | 13958FG   | V20   | \$49.91    |
| White-Polyester  | 165°F | 13958MC/W | V20   | \$49.91    |
| White-Polyester  | 205°F | 13958ME/W | V20   | \$49.91    |
| White-Polyester  | 280°F | 13958MG/W | V20   | \$49.91    |
| <b>VK301 - 5.6 (81) K Factor - 1/2 in NPT - UPRIGHT (QR)</b>   |       |           |       |            |
| Standard Brass   | 165°F | 12279AC   | V13.3 | \$48.18    |
| Standard Brass   | 205°F | 12279AE   | V13.3 | \$48.18    |
| Standard Brass   | 280°F | 12279AG   | V13.3 | \$48.18    |
| Chrome   | 165°F | 12279FC   | V13.3 | \$54.67    |
| Chrome   | 205°F | 12279FE   | V13.3 | \$54.67    |
| Chrome   | 280°F | 12279FG   | V13.3 | \$54.67    |
| White-Polyester  | 165°F | 12279MC/W | V13.3 | \$54.67    |
| White-Polyester  | 205°F | 12279ME/W | V13.3 | \$54.67    |
| White-Polyester  | 280°F | 12279MG/W | V13.3 | \$54.67    |
| Black-Polyester  | 165°F | 12279MC/B | V20   | \$54.45    |
| Black-Polyester  | 205°F | 12279ME/B | V20   | \$54.45    |
| Black-Polyester  | 280°F | 12279MG/B | V20   | \$54.45    |
| <b>VK351 - 8.0 (115) K Factor - 3/4 in NPT - UPRIGHT (QR)</b>  |       |           |       |            |
| Standard Brass   | 165°F | 13976AC   | V14   | \$43.98    |
| Standard Brass   | 205°F | 13976AE   | V14   | \$43.98    |
| Standard Brass   | 280°F | 13976AG   | V14   | \$43.98    |
| Chrome   | 165°F | 13976FC   | V14   | \$46.02    |
| Chrome   | 205°F | 13976FE   | V14   | \$46.02    |
| Chrome   | 280°F | 13976FG   | V14   | \$46.02    |
| White-Polyester  | 165°F | 13976MC/W | V14   | \$48.57    |
| White-Polyester  | 205°F | 13976ME/W | V14   | \$48.57    |
| White-Polyester  | 280°F | 13976MG/W | V14   | \$48.57    |
| Std Sprinkler Wrench   |       | 10896W/B  | V20   | \$56.27    |

|                            |       |           |       |            |
|--|-------|-----------|-------|------------|
| Microfast® Model M<br>Quick Response<br>Standard Coverage<br>FUSIBLE LINK <sup>1</sup><br>Pendent Sprinklers |       |           |       |            |
| Finish   | Temp  | Part #    | IPG   | List Price |
| <b>VK330 - 2.8 (40) K Factor - 1/2 in NPT - PENDENT (QR)</b>   |       |           |       |            |
| Standard Brass   | 165°F | 13960AC   | V14.2 | \$47.64    |
| Standard Brass   | 205°F | 13960AE   | V14.2 | \$47.64    |
| Standard Brass   | 280°F | 13960AG   | V14.2 | \$47.64    |
| Chrome   | 165°F | 13960FC   | V14.2 | \$49.54    |
| Chrome   | 205°F | 13960FE   | V14.2 | \$50.01    |
| Chrome   | 280°F | 13960FG   | V14.2 | \$49.54    |
| White-Polyester  | 165°F | 13960MC/W | V14.2 | \$53.09    |
| White-Polyester  | 205°F | 13960ME/W | V14.2 | \$53.09    |
| White-Polyester  | 280°F | 13960MG/W | V14.2 | \$53.09    |
| <b>VK332 - 4.2 (60) K Factor - 1/2 in NPT - PENDENT (QR)</b>   |       |           |       |            |
| Standard Brass   | 165°F | 13961AC   | V14.2 | \$49.42    |
| Standard Brass   | 205°F | 13961AE   | V14.2 | \$49.42    |
| Standard Brass   | 280°F | 13961AG   | V14.2 | \$49.42    |
| Chrome   | 165°F | 13961FC   | V14.2 | \$52.46    |
| Chrome   | 205°F | 13961FE   | V14.2 | \$52.96    |
| Chrome   | 280°F | 13961FG   | V14.2 | \$52.96    |
| White-Polyester  | 165°F | 13961MC/W | V14.2 | \$52.96    |
| White-Polyester  | 205°F | 13961ME/W | V14.2 | \$52.96    |
| White-Polyester  | 280°F | 13961MG/W | V14.2 | \$52.96    |
| <b>VK303 - 5.6 (81) K Factor - 1/2 in NPT - PENDENT (QR)</b>   |       |           |       |            |
| Standard Brass   | 165°F | 12275AC   | V13.3 | \$48.18    |
| Standard Brass   | 205°F | 12275AE   | V13.3 | \$48.18    |
| Standard Brass   | 280°F | 12275AG   | V13.3 | \$48.18    |
| Chrome   | 165°F | 12275FC   | V13.3 | \$54.67    |
| Chrome   | 205°F | 12275FE   | V13.3 | \$54.67    |
| Chrome   | 280°F | 12275FG   | V13.3 | \$54.67    |
| White-Polyester  | 165°F | 12275MC/W | V13.3 | \$54.67    |
| White-Polyester  | 205°F | 12275ME/W | V13.3 | \$54.67    |
| White-Polyester  | 280°F | 12275MG/W | V13.3 | \$54.67    |
| Black-Polyester  | 165°F | 12275MC/B | V20   | \$54.45    |
| Black-Polyester  | 205°F | 12275ME/B | V20   | \$54.45    |
| Black-Polyester  | 280°F | 12275MG/B | V20   | \$54.45    |
| <b>VK353 - 8.0 (115) K Factor - 3/4 in NPT - PENDENT (QR)</b>  |       |           |       |            |
| Standard Brass   | 165°F | 13975AC   | V14   | \$41.43    |
| Standard Brass   | 205°F | 13975AE   | V14   | \$41.43    |
| Standard Brass   | 280°F | 13975AG   | V14   | \$41.43    |
| Chrome   | 165°F | 13975FC   | V14   | \$43.44    |
| Chrome   | 205°F | 13975FE   | V14   | \$43.44    |
| Chrome   | 280°F | 13975FG   | V14   | \$43.44    |
| White-Polyester  | 165°F | 13975MC/W | V14   | \$45.36    |
| White-Polyester  | 205°F | 13975ME/W | V14   | \$45.36    |
| White-Polyester  | 280°F | 13975MG/W | V14   | \$45.36    |
| Std Sprinkler Wrench   |       | 10896W/B  | V20   | \$56.27    |
| Wrench for Recessed  |       | 16036W/B  | V20   | \$115.04   |

(1) Select fusible link sprinklers are also available in painted black and black corrosion resistant (fluoropolymer) finish.  
Contact customer service for price and availability.

|  |       |           |       |            |
|---|-------|-----------|-------|------------|
| <b>Microfast® Model M</b>   |       |           |       |            |
| <b>Quick Response</b>   |       |           |       |            |
| <b>Standard Coverage</b>  |       |           |       |            |
| <b>FUSIBLE LINK<sup>1</sup></b>   |       |           |       |            |
| <b>Horizontal Sidewall</b>  |       |           |       |            |
| Finish  | Temp  | Part #    | IPG   | List Price |
| <b>VK334 - 2.8 (40) K Factor - 1/2 in NPT - HSW (QR)</b>                          |       |           |       |            |
| Standard Brass  | 165°F | 13962AC   | V20   | \$45.54    |
| Standard Brass  | 205°F | 13962AE   | V20   | \$45.54    |
| Standard Brass  | 280°F | 13962AG   | V20   | \$45.54    |
| Chrome  | 165°F | 13962FC   | V20   | \$47.87    |
| Chrome  | 205°F | 13962FE   | V14.2 | \$47.41    |
| Chrome  | 280°F | 13962FG   | V14.2 | \$47.41    |
| White-Polyester   | 165°F | 13962MC/W | V14.2 | \$47.41    |
| White-Polyester   | 205°F | 13962ME/W | V14.2 | \$47.41    |
| White-Polyester   | 280°F | 13962MG/W | V14.2 | \$47.41    |
| <b>VK307 - 5.6 (81) K Factor - 1/2 in NPT - HSW - LH</b>                          |       |           |       |            |
| Standard Brass  | 165°F | 13948AC   | V13   | \$51.12    |
| Standard Brass  | 205°F | 13948AE   | V13   | \$51.12    |
| Standard Brass  | 280°F | 13948AG   | V13   | \$51.12    |
| Chrome  | 165°F | 13948FC   | V13   | \$53.16    |
| Chrome  | 205°F | 13948FE   | V13   | \$53.16    |
| Chrome  | 280°F | 13948FG   | V13   | \$53.16    |
| White-Polyester   | 165°F | 13948MC/W | V13   | \$58.42    |
| White-Polyester   | 205°F | 13948ME/W | V13   | \$58.42    |
| White-Polyester   | 280°F | 13948MG/W | V13   | \$58.42    |
| <b>VK308 - 5.6 (81) K Factor - 1/2 in NPT - HSW - OH</b>                          |       |           |       |            |
| Standard Brass  | 165°F | 13950AC   | V13   | \$52.49    |
| Standard Brass  | 205°F | 13950AE   | V13   | \$52.49    |
| Standard Brass  | 280°F | 13950AG   | V13   | \$52.49    |
| Chrome  | 165°F | 13950FC   | V13.1 | \$54.55    |
| Chrome  | 205°F | 13950FE   | V13.1 | \$54.55    |
| Chrome  | 280°F | 13950FG   | V13.1 | \$54.55    |
| White-Polyester   | 165°F | 13950MC/W | V13.2 | \$58.69    |
| White-Polyester   | 205°F | 13950ME/W | V13.2 | \$58.69    |
| White-Polyester   | 280°F | 13950MG/W | V13.2 | \$58.69    |
| Std Sprinkler Wrench  |       | 10896W/B  | V20   | \$56.27    |
| Wrench for Recessed   |       | 13655W/B  | V20   | \$118.26   |

|  |       |           |       |            |
|---|-------|-----------|-------|------------|
| <b>Microfast® Model M</b>   |       |           |       |            |
| <b>Quick Response</b>   |       |           |       |            |
| <b>Standard Coverage</b>  |       |           |       |            |
| <b>FUSIBLE LINK<sup>1</sup></b>   |       |           |       |            |
| <b>Conventional</b>   |       |           |       |            |
| Finish  | Temp  | Part #    | IPG   | List Price |
| <b>VK311 - 5.6 (81) K Factor - 1/2 in NPT - Conventional</b>                        |       |           |       |            |
| Standard Brass  | 165°F | 13952AC   | V13   | \$44.50    |
| Standard Brass  | 205°F | 13952AE   | V13   | \$44.50    |
| Standard Brass  | 280°F | 13952AG   | V13   | \$44.50    |
| Chrome  | 165°F | 13952FC   | V13.1 | \$47.72    |
| Chrome  | 205°F | 13952FE   | V13.1 | \$47.72    |
| Chrome  | 280°F | 13952FG   | V13.1 | \$47.72    |
| White-Polyester   | 165°F | 13952MC/W | V13.2 | \$47.72    |
| White-Polyester   | 205°F | 13952ME/W | V13.2 | \$47.72    |
| White-Polyester   | 280°F | 13952MG/W | V13.2 | \$47.72    |
| Std Sprinkler Wrench  |       | 10896W/B  | V20   | \$56.27    |

|  |       |          |     |            |
|--|-------|----------|-----|------------|
| <b>Microfast® Model M</b>  |       |          |     |            |
| <b>Quick Response</b>  |       |          |     |            |
| <b>Standard Coverage</b>   |       |          |     |            |
| <b>FUSIBLE LINK<sup>1</sup></b>  |       |          |     |            |
| <b>Vertical Sidewall</b>   |       |          |     |            |
| Finish   | Temp  | Part #   | IPG | List Price |
| <b>VK309 - 5.6 (81) K Factor - 1/2 in NPT - VSW - LH</b>                           |       |          |     |            |
| Standard Brass   | 165°F | 13951AC  | V20 | \$47.19    |
| Standard Brass   | 205°F | 13951AE  | V20 | \$47.19    |
| N/A  |       |          |     |            |
| Chrome   | 165°F | 13951FC  | V20 | \$51.38    |
| Chrome   | 205°F | 13951FE  | V20 | \$51.38    |
| N/A  |       |          |     |            |
| Std Sprinkler Wrench   |       | 10896W/B | V20 | \$53.59    |

|  |       |           |     |            |
|--|-------|-----------|-----|------------|
| <b>Microfast® Model M</b>  |       |           |     |            |
| <b>Quick Response</b>  |       |           |     |            |
| <b>Standard Coverage</b>   |       |           |     |            |
| <b>FUSIBLE LINK<sup>1</sup></b>  |       |           |     |            |
| <b>Conventional</b>  |       |           |     |            |
| Finish   | Temp  | Part #    | IPG | List Price |
| <b>VK355 - 8.0 (115) K Factor - 3/4 in NPT - Conventional</b>                        |       |           |     |            |
| Standard Brass   | 165°F | 13979AC   | V20 | \$43.21    |
| Standard Brass   | 205°F | 13979AE   | V20 | \$43.21    |
| Standard Brass   | 280°F | 13979AG   | V20 | \$43.21    |
| Chrome   | 165°F | 13979FC   | V20 | \$46.94    |
| Chrome   | 205°F | 13979FE   | V20 | \$46.94    |
| Chrome   | 280°F | 13979FG   | V20 | \$46.94    |
| White-Polyester  | 165°F | 13979MC/W | V20 | \$46.94    |
| White-Polyester  | 205°F | 13979ME/W | V20 | \$46.94    |
| White-Polyester  | 280°F | 13979MG/W | V20 | \$46.94    |
| Std Sprinkler Wrench   |       | 10896W/B  | V20 | \$56.27    |

(1) Select fusible link sprinklers also available in Black-Polyester finish (contact customer service for price & availability).



|   |                                 |               |            |                   |
|---|---------------------------------|---------------|------------|-------------------|
|  | <b>Microfast® Model M</b>       |               |            |                   |
|   | <b>Quick Response</b>           |               |            |                   |
|   | <b>Standard Coverage</b>        |               |            |                   |
|   | <b>FUSIBLE LINK<sup>1</sup></b> |               |            |                   |
|   | <b>Upright</b>                  |               |            |                   |
| <b>HIGH PRESSURE</b>  |                                 |               |            |                   |
| <b>Finish</b>   | <b>Temp</b>                     | <b>Part #</b> | <b>IPG</b> | <b>List Price</b> |
| <b>VK341 - 2.8 (40) K Factor - 1/2 in NPT - UPRIGHT (HP)</b>                      |                                 |               |            |                   |
| Standard Brass  | 165°F                           | 13963AC       | V14.2      | \$49.42           |
| Standard Brass  | 205°F                           | 13963AE       | V14.2      | \$49.42           |
| Standard Brass  | 280°F                           | 13963AG       | V14.2      | \$49.42           |
| Chrome  | 165°F                           | 13963FC       | V14.2      | \$52.46           |
| Chrome  | 205°F                           | 13963FE       | V14.2      | \$52.46           |
| Chrome  | 280°F                           | 13963FG       | V14.2      | \$52.46           |
| White-Polyester   | 165°F                           | 13963MC/W     | V14.2      | \$52.46           |
| White-Polyester   | 205°F                           | 13963ME/W     | V14.2      | \$52.46           |
| White-Polyester   | 280°F                           | 13963MG/W     | V14.2      | \$52.46           |
| <b>VK316 - 5.6 (81) K Factor - 1/2 in NPT - UPRIGHT (HP)</b>                      |                                 |               |            |                   |
| Standard Brass  | 165°F                           | 13953AC       | V13        | \$46.07           |
| Standard Brass  | 205°F                           | 13953AE       | V13        | \$46.07           |
| Standard Brass  | 280°F                           | 13953AG       | V13        | \$46.07           |
| Chrome  | 165°F                           | 13953FC       | V13.1      | \$49.22           |
| Chrome  | 205°F                           | 13953FE       | V13.1      | \$49.22           |
| Chrome  | 280°F                           | 13953FG       | V13.1      | \$49.22           |
| White-Polyester   | 165°F                           | 13953MC/W     | V13.2      | \$49.22           |
| White-Polyester   | 205°F                           | 13953ME/W     | V13.2      | \$49.22           |
| White-Polyester   | 280°F                           | 13953MG/W     | V13.2      | \$49.22           |
| Std Sprinkler Wrench  |                                 | 10896W/B      | V20        | \$56.27           |

|   |                                 |               |            |                   |
|---|---------------------------------|---------------|------------|-------------------|
|  | <b>Microfast® Model M</b>       |               |            |                   |
|   | <b>Quick Response</b>           |               |            |                   |
|   | <b>Standard Coverage</b>        |               |            |                   |
|   | <b>FUSIBLE LINK<sup>1</sup></b> |               |            |                   |
|   | <b>Horizontal Sidewall</b>      |               |            |                   |
| <b>HIGH PRESSURE</b>  |                                 |               |            |                   |
| <b>Finish</b>   | <b>Temp</b>                     | <b>Part #</b> | <b>IPG</b> | <b>List Price</b> |
| <b>VK346 - 2.8 (40) K Factor - 1/2 in NPT - HSW (HP)</b>                            |                                 |               |            |                   |
| Standard Brass  | 165°F                           | 13965AC       | V20        | \$49.73           |
| Standard Brass  | 205°F                           | 13965AE       | V20        | \$49.73           |
| Standard Brass  | 280°F                           | 13965AG       | V20        | \$49.73           |
| Chrome  | 165°F                           | 13965FC       | V20        | \$52.55           |
| Chrome  | 205°F                           | 13965FE       | V20        | \$52.55           |
| Chrome  | 280°F                           | 13965FG       | V20        | \$52.55           |
| White-Polyester   | 165°F                           | 13965MC/W     | V20        | \$52.55           |
| White-Polyester   | 205°F                           | 13965ME/W     | V20        | \$52.55           |
| White-Polyester   | 280°F                           | 13965MG/W     | V20        | \$52.55           |
| Std Sprinkler Wrench  |                                 | 10896W/B      | V20        | \$56.27           |
| Wrench for Recessed   |                                 | 13577W/B      | V20        | \$104.58          |

|  |                                 |               |            |                   |
|--|---------------------------------|---------------|------------|-------------------|
|  | <b>Microfast® Model M</b>       |               |            |                   |
|  | <b>Quick Response</b>           |               |            |                   |
|  | <b>Standard Coverage</b>        |               |            |                   |
|  | <b>FUSIBLE LINK<sup>1</sup></b> |               |            |                   |
|  | <b>Pendent</b>                  |               |            |                   |
| <b>HIGH PRESSURE</b>   |                                 |               |            |                   |
| <b>Finish</b>  | <b>Temp</b>                     | <b>Part #</b> | <b>IPG</b> | <b>List Price</b> |
| <b>VK343 - 2.8 (40) K Factor - 1/2 in NPT - PENDENT (HP)</b>                       |                                 |               |            |                   |
| Standard Brass   | 165°F                           | 13964AC       | V13        | \$51.53           |
| Standard Brass   | 205°F                           | 13964AE       | V13        | \$51.53           |
| Standard Brass   | 280°F                           | 13964AG       | V13        | \$51.53           |
| Chrome   | 165°F                           | 13964FC       | V13.1      | \$56.66           |
| Chrome   | 205°F                           | 13964FE       | V13.1      | \$56.66           |
| Chrome   | 280°F                           | 13964FG       | V13.1      | \$56.66           |
| White-Polyester  | 165°F                           | 13964MC/W     | V13.2      | \$56.66           |
| White-Polyester  | 205°F                           | 13964ME/W     | V13.2      | \$56.66           |
| White-Polyester  | 280°F                           | 13964MG/W     | V13.2      | \$56.66           |
| <b>VK318 - 5.6 (81) K Factor - 1/2 in NPT - PENDENT (HP)</b>                       |                                 |               |            |                   |
| Standard Brass   | 165°F                           | 13954AC       | V13        | \$46.07           |
| Standard Brass   | 205°F                           | 13954AE       | V13        | \$46.07           |
| Standard Brass   | 280°F                           | 13954AG       | V13        | \$46.07           |
| Chrome   | 165°F                           | 13954FC       | V13.1      | \$49.09           |
| Chrome   | 205°F                           | 13954FE       | V13.1      | \$49.09           |
| Chrome   | 280°F                           | 13954FG       | V13.1      | \$49.09           |
| White-Polyester  | 165°F                           | 13954MC/W     | V13.2      | \$49.09           |
| White-Polyester  | 205°F                           | 13954ME/W     | V13.2      | \$49.09           |
| White-Polyester  | 280°F                           | 13954MG/W     | V13.2      | \$49.09           |
| Std Sprinkler Wrench   |                                 | 10896W/B      | V20        | \$56.27           |
| Wrench for Recessed  |                                 | 16036W/B      | V20        | \$115.04          |

|  |                                 |               |            |                   |
|--|---------------------------------|---------------|------------|-------------------|
|  | <b>Microfast® Model M</b>       |               |            |                   |
|  | <b>Quick Response</b>           |               |            |                   |
|  | <b>Standard Coverage</b>        |               |            |                   |
|  | <b>FUSIBLE LINK<sup>1</sup></b> |               |            |                   |
|  | <b>Horizontal Sidewall</b>      |               |            |                   |
| <b>HIGH PRESSURE</b>   |                                 |               |            |                   |
| <b>Finish</b>  | <b>Temp</b>                     | <b>Part #</b> | <b>IPG</b> | <b>List Price</b> |
| <b>VK320 - 5.6 (81) K Factor - 1/2 in NPT - HSW (HP)</b>                             |                                 |               |            |                   |
| Standard Brass   | 165°F                           | 13955AC       | V14        | \$48.84           |
| Standard Brass   | 205°F                           | 13955AE       | V14        | \$48.84           |
| Standard Brass   | 280°F                           | 13955AG       | V14        | \$48.84           |
| Chrome   | 165°F                           | 13955FC       | V14        | \$51.82           |
| Chrome   | 205°F                           | 13955FE       | V14        | \$51.82           |
| Chrome   | 280°F                           | 13955FG       | V14        | \$51.82           |
| White-Polyester  | 165°F                           | 13955MC/W     | V14        | \$51.82           |
| White-Polyester  | 205°F                           | 13955ME/W     | V14        | \$51.82           |
| White-Polyester  | 280°F                           | 13955MG/W     | V14        | \$51.82           |
| Std Sprinkler Wrench   |                                 | 10896W/B      | V20        | \$56.27           |
| Wrench for Recessed  |                                 | 13577W/B      | V20        | \$104.58          |

(1) Select fusible link sprinklers are also available in Black-Polyester finish  
Contact customer service for price and availability.

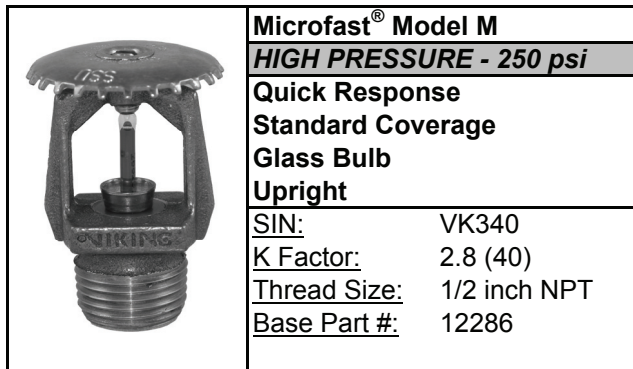

**Microfast® Model M**  
**HIGH PRESSURE - 250 psi**  
**Quick Response**  
**Standard Coverage**  
**Glass Bulb**  
**Upright**  
**SIN:** VK340  
**K Factor:** 2.8 (40)  
**Thread Size:** 1/2 inch NPT  
**Base Part #:** 12286

| Finish                               | Temp  | Part #    | IPG   | List Price |
|--------------------------------------|-------|-----------|-------|------------|
| Standard Brass                       | 155°F | 12286AB   | V14.2 | \$43.11    |
| Standard Brass                       | 175°F | 12286AD   | V14.2 | \$43.11    |
| Standard Brass                       | 200°F | 12286AE   | V14.2 | \$43.11    |
| Standard Brass                       | 286°F | 12286AG   | V14.2 | \$43.11    |
| Chrome                               | 155°F | 12286FB   | V14.2 | \$46.20    |
| Chrome                               | 175°F | 12286FD   | V14.2 | \$46.20    |
| Chrome                               | 200°F | 12286FE   | V14.2 | \$46.20    |
| Chrome                               | 286°F | 12286FG   | V14.2 | \$46.20    |
| White-Polyester <sup>1</sup>         | 155°F | 12286MB/W | V14.2 | \$46.20    |
| White-Polyester                      | 175°F | 12286MD/W | V14.2 | \$46.20    |
| White-Polyester                      | 200°F | 12286ME/W | V14.2 | \$46.20    |
| White-Polyester                      | 286°F | 12286MG/W | V14.2 | \$46.20    |
| Black-Polyester <sup>1</sup>         | 155°F | 12286MB/B | V20   | \$48.01    |
| Black-Polyester                      | 175°F | 12286MD/B | V20   | \$48.01    |
| Black-Polyester                      | 200°F | 12286ME/B | V20   | \$48.01    |
| Black-Polyester                      | 286°F | 12286MG/B | V20   | \$48.01    |
| Black (flouropolymer) <sup>1,2</sup> | 155°F | 12286NB   | V20   | \$58.37    |
| Black (flouropolymer) <sup>1,2</sup> | 175°F | 12286ND   | V20   | \$58.37    |
| Black (flouropolymer) <sup>1,2</sup> | 200°F | 12286NE   | V20   | \$58.37    |
| Black (flouropolymer) <sup>1,2</sup> | 286°F | 12286NG   | V20   | \$58.37    |
| Std Sprinkler Wrench                 |       | 10896W/B  | V20   | \$56.27    |

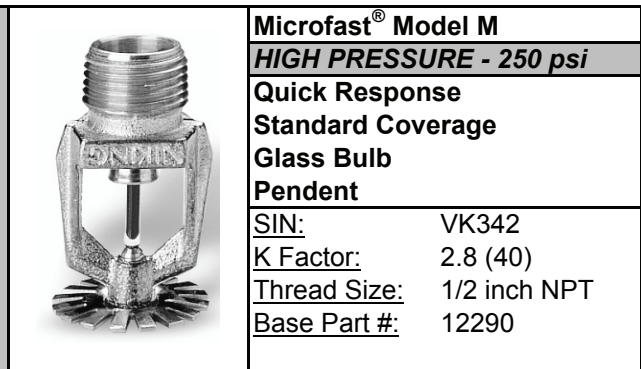

**Microfast® Model M**  
**HIGH PRESSURE - 250 psi**  
**Quick Response**  
**Standard Coverage**  
**Glass Bulb**  
**Pendent**  
**SIN:** VK342  
**K Factor:** 2.8 (40)  
**Thread Size:** 1/2 inch NPT  
**Base Part #:** 12290

| Finish                               | Temp  | Part #    | IPG   | List Price |
|--------------------------------------|-------|-----------|-------|------------|
| Standard Brass                       | 155°F | 12290AB   | V13   | \$43.11    |
| Standard Brass                       | 175°F | 12290AD   | V13   | \$43.11    |
| Standard Brass                       | 200°F | 12290AE   | V13   | \$43.11    |
| Standard Brass                       | 286°F | 12290AG   | V13   | \$43.11    |
| Chrome                               | 155°F | 12290FB   | V13.1 | \$46.20    |
| Chrome                               | 175°F | 12290FD   | V13.1 | \$46.20    |
| Chrome                               | 200°F | 12290FE   | V13.1 | \$46.20    |
| Chrome                               | 286°F | 12290FG   | V13.1 | \$46.20    |
| White-Polyester <sup>1</sup>         | 155°F | 12290MB/W | V13.2 | \$46.20    |
| White-Polyester                      | 175°F | 12290MD/W | V13.2 | \$46.20    |
| White-Polyester                      | 200°F | 12290ME/W | V13.2 | \$46.20    |
| White-Polyester                      | 286°F | 12290MG/W | V13.2 | \$46.20    |
| Black-Polyester <sup>1</sup>         | 155°F | 12290MB/B | V20   | \$48.01    |
| Black-Polyester                      | 175°F | 12290MD/B | V20   | \$48.01    |
| Black-Polyester                      | 200°F | 12290ME/B | V20   | \$48.01    |
| Black-Polyester                      | 286°F | 12290MG/B | V20   | \$48.01    |
| Black (flouropolymer) <sup>1,2</sup> | 155°F | 12290NB   | V20   | \$58.37    |
| Black (flouropolymer) <sup>1,2</sup> | 175°F | 12290ND   | V20   | \$58.37    |
| Black (flouropolymer) <sup>1,2</sup> | 200°F | 12290NE   | V20   | \$58.37    |
| Black (flouropolymer) <sup>1,2</sup> | 286°F | 12290NG   | V20   | \$58.37    |
| Std Sprinkler Wrench                 |       | 10896W/B  | V20   | \$56.27    |
| Wrench for Recessed                  |       | 16036W/B  | V20   | \$115.04   |

- (1) Suitable for decorative applications and are UL listed for corrosion resistance.
- (2) Also available with coated waterways without glass bulbs.

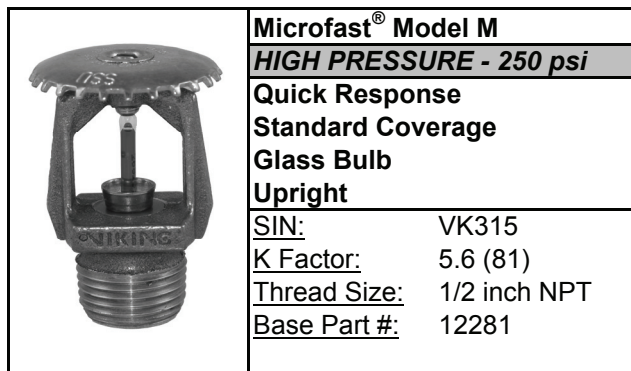

| Finish                               | Temp  | Part #    | IPG   | List Price |
|--------------------------------------|-------|-----------|-------|------------|
| Standard Brass                       | 155°F | 12281AB   | V13   | \$36.12    |
| Standard Brass                       | 175°F | 12281AD   | V13   | \$36.12    |
| Standard Brass                       | 200°F | 12281AE   | V13   | \$36.12    |
| Standard Brass                       | 286°F | 12281AG   | V13   | \$36.12    |
| Chrome                               | 155°F | 12281FB   | V13.1 | \$39.07    |
| Chrome                               | 175°F | 12281FD   | V13.1 | \$39.07    |
| Chrome                               | 200°F | 12281FE   | V13.1 | \$39.07    |
| Chrome                               | 286°F | 12281FG   | V13.1 | \$39.07    |
| White-Polyester <sup>1</sup>         | 155°F | 12281MB/W | V13.2 | \$39.07    |
| White-Polyester                      | 175°F | 12281MD/W | V13.2 | \$39.07    |
| White-Polyester                      | 200°F | 12281ME/W | V13.2 | \$39.07    |
| White-Polyester                      | 286°F | 12281MG/W | V13.2 | \$39.07    |
| Black-Polyester <sup>1</sup>         | 155°F | 12281MB/B | V20   | \$40.60    |
| Black-Polyester                      | 175°F | 12281MD/B | V20   | \$40.60    |
| Black-Polyester                      | 200°F | 12281ME/B | V20   | \$40.60    |
| Black-Polyester                      | 286°F | 12281MG/B | V20   | \$40.60    |
| Black (flouropolymer) <sup>1,2</sup> | 155°F | 12281NB   | V20   | \$52.36    |
| Black (flouropolymer) <sup>1,2</sup> | 175°F | 12281ND   | V20   | \$52.36    |
| Black (flouropolymer) <sup>1,2</sup> | 200°F | 12281NE   | V20   | \$52.36    |
| Black (flouropolymer) <sup>1,2</sup> | 286°F | 12281NG   | V20   | \$52.36    |
| Std Sprinkler Wrench                 |       | 10896W/B  | V20   | \$56.27    |

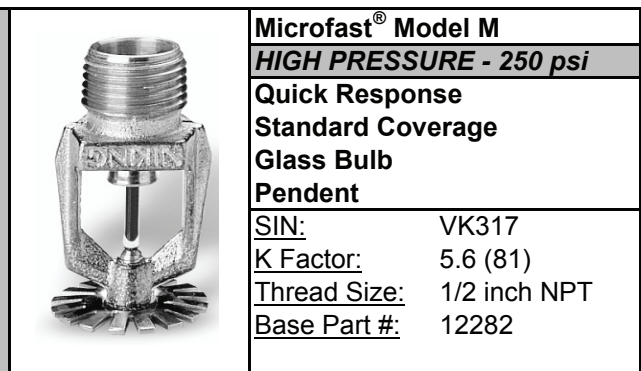

| Finish                               | Temp  | Part #    | IPG   | List Price |
|--------------------------------------|-------|-----------|-------|------------|
| Standard Brass                       | 155°F | 12282AB   | V13   | \$36.12    |
| Standard Brass                       | 175°F | 12282AD   | V13   | \$36.12    |
| Standard Brass                       | 200°F | 12282AE   | V13   | \$36.12    |
| Standard Brass                       | 286°F | 12282AG   | V13   | \$36.12    |
| Chrome                               | 155°F | 12282FB   | V13.1 | \$39.07    |
| Chrome                               | 175°F | 12282FD   | V13.1 | \$39.07    |
| Chrome                               | 200°F | 12282FE   | V13.1 | \$39.07    |
| Chrome                               | 286°F | 12282FG   | V13.1 | \$39.07    |
| White-Polyester <sup>1</sup>         | 155°F | 12282MB/W | V13.2 | \$39.07    |
| White-Polyester                      | 175°F | 12282MD/W | V13.2 | \$39.07    |
| White-Polyester                      | 200°F | 12282ME/W | V13.2 | \$39.07    |
| White-Polyester                      | 286°F | 12282MG/W | V13.2 | \$39.07    |
| Black-Polyester <sup>1</sup>         | 155°F | 12282MB/B | V20   | \$40.60    |
| Black-Polyester                      | 175°F | 12282MD/B | V20   | \$40.60    |
| Black-Polyester                      | 200°F | 12282ME/B | V20   | \$40.60    |
| Black-Polyester                      | 286°F | 12282MG/B | V20   | \$40.60    |
| Black (flouropolymer) <sup>1,2</sup> | 155°F | 12282NB   | V13   | \$50.40    |
| Black (flouropolymer) <sup>1,2</sup> | 175°F | 12282ND   | V13   | \$50.40    |
| Black (flouropolymer) <sup>1,2</sup> | 200°F | 12282NE   | V13   | \$50.40    |
| Black (flouropolymer) <sup>1,2</sup> | 286°F | 12282NG   | V13   | \$50.40    |
| Std Sprinkler Wrench                 |       | 10896W/B  | V20   | \$56.27    |
| Wrench for Recessed                  |       | 16036W/B  | V20   | \$115.04   |

- (1) Suitable for decorative applications and are UL listed for corrosion resistance.
- (2) Also available with coated waterways without glass bulbs.

|   |                                |                    |  |  |
|---|--------------------------------|--------------------|--|--|
|  | <b>Microfast® Model M</b>      |                    |  |  |
|   | <b>HIGH PRESSURE - 250 psi</b> |                    |  |  |
|   | <b>Quick Response</b>          |                    |  |  |
|   | <b>Standard Coverage</b>       |                    |  |  |
|   | <b>Glass Bulb</b>              |                    |  |  |
| <b>Horizontal Sidewall</b>  |                                |                    |  |  |
| SIN:  |                                | VK344 <sup>1</sup> |  |  |
| K Factor:   |                                | 2.8 (40)           |  |  |
| Thread Size:  |                                | 1/2 inch NPT       |  |  |
| Base Part #:  |                                | 12287              |  |  |

| Finish                               | Temp  | Part #    | IPG | List Price |
|--------------------------------------|-------|-----------|-----|------------|
| Standard Brass                       | 155°F | 12287AB   | V20 | \$45.33    |
| Standard Brass                       | 175°F | 12287AD   | V20 | \$45.33    |
| Standard Brass                       | 200°F | 12287AE   | V20 | \$45.33    |
| Standard Brass                       | 286°F | 12287AG   | V20 | \$45.33    |
| Chrome                               | 155°F | 12287FB   | V20 | \$48.07    |
| Chrome                               | 175°F | 12287FD   | V20 | \$48.07    |
| Chrome                               | 200°F | 12287FE   | V20 | \$48.07    |
| Chrome                               | 286°F | 12287FG   | V20 | \$48.07    |
| White-Polyester <sup>3</sup>         | 155°F | 12287MB/W | V20 | \$48.07    |
| White-Polyester                      | 175°F | 12287MD/W | V20 | \$48.07    |
| White-Polyester                      | 200°F | 12287ME/W | V20 | \$48.07    |
| White-Polyester                      | 286°F | 12287MG/W | V20 | \$48.07    |
| Black-Polyester <sup>3</sup>         | 155°F | 12287MB/B | V20 | \$48.07    |
| Black-Polyester                      | 175°F | 12287MD/B | V20 | \$48.07    |
| Black-Polyester                      | 200°F | 12287ME/B | V20 | \$48.07    |
| Black-Polyester                      | 286°F | 12287MG/B | V20 | \$48.07    |
| Black (flouropolymer) <sup>3,4</sup> | 155°F | 12287NB   | V20 | \$62.93    |
| Black (flouropolymer)                | 175°F | 12287ND   | V20 | \$62.93    |
| Black (flouropolymer)                | 200°F | 12287NE   | V20 | \$62.93    |
| Black (flouropolymer)                | 286°F | 12287NG   | V20 | \$62.93    |
| Std Sprinkler Wrench                 |       | 10896W/B  | V20 | \$56.27    |
| Wrench for Recessed                  |       | 13655W/B  | V20 | \$118.26   |

|  |                                |                    |  |  |
|--|--------------------------------|--------------------|--|--|
|  | <b>Microfast® Model M</b>      |                    |  |  |
|  | <b>HIGH PRESSURE - 250 psi</b> |                    |  |  |
|  | <b>Quick Response</b>          |                    |  |  |
|  | <b>Standard Coverage</b>       |                    |  |  |
|  | <b>Glass Bulb</b>              |                    |  |  |
| <b>Horizontal Sidewall</b>   |                                |                    |  |  |
| SIN:   |                                | VK319 <sup>2</sup> |  |  |
| K Factor:  |                                | 5.6 (81)           |  |  |
| Thread Size:   |                                | 1/2 inch NPT       |  |  |
| Base Part #:   |                                | 12285              |  |  |

| Finish                               | Temp  | Part #    | IPG | List Price |
|--------------------------------------|-------|-----------|-----|------------|
| Standard Brass                       | 155°F | 12285AB   | V14 | \$41.53    |
| Standard Brass                       | 175°F | 12285AD   | V14 | \$41.53    |
| Standard Brass                       | 200°F | 12285AE   | V14 | \$41.53    |
| Standard Brass                       | 286°F | 12285AG   | V14 | \$41.53    |
| Chrome                               | 155°F | 12285FB   | V14 | \$44.68    |
| Chrome                               | 175°F | 12285FD   | V14 | \$44.68    |
| Chrome                               | 200°F | 12285FE   | V14 | \$44.68    |
| Chrome                               | 286°F | 12285FG   | V14 | \$44.68    |
| White-Polyester <sup>3</sup>         | 155°F | 12285MB/W | V14 | \$44.68    |
| White-Polyester                      | 175°F | 12285MD/W | V14 | \$44.68    |
| White-Polyester                      | 200°F | 12285ME/W | V14 | \$44.68    |
| White-Polyester                      | 286°F | 12285MG/W | V14 | \$44.68    |
| Black-Polyester <sup>3</sup>         | 155°F | 12285MB/B | V20 | \$46.41    |
| Black-Polyester                      | 175°F | 12285MD/B | V20 | \$46.41    |
| Black-Polyester                      | 200°F | 12285ME/B | V20 | \$46.41    |
| Black-Polyester                      | 286°F | 12285MG/B | V20 | \$46.41    |
| Black (flouropolymer) <sup>3,4</sup> | 155°F | 12285NB   | V20 | \$57.15    |
| Black (flouropolymer)                | 175°F | 12285ND   | V20 | \$57.15    |
| Black (flouropolymer)                | 200°F | 12285NE   | V20 | \$57.15    |
| Black (flouropolymer)                | 286°F | 12285NG   | V20 | \$57.15    |
| Std Sprinkler Wrench                 |       | 10896W/B  | V20 | \$56.27    |
| Wrench for Recessed                  |       | 13655W/B  | V20 | \$118.26   |

- (1) Light hazard
- (2) Light / Ordinary hazard
- (3) Suitable for decorative applications and are UL listed for corrosion resistance.
- (4) Also available with coated waterways without glass bulbs.



**Microfast® - Stainless Steel**  
**CORROSION RESISTANT**  
**Quick Response**  
**Standard Coverage**  
**Glass Bulb**  
**Stainless Steel - Upright**  
SIN: VK338  
K Factor: 5.6 (81)  
Thread Size: 1/2 inch NPT  
Base Part #: 14692

| Finish               | Temp  | Part #   | IPG   | List Price |
|----------------------|-------|----------|-------|------------|
| Stainless Steel      | 135°F | 14692A   | V20.3 | \$412.08   |
| Stainless Steel      | 155°F | 14692B   | V20.3 | \$412.08   |
| Stainless Steel      | 175°F | 14692D   | V20.3 | \$412.08   |
| Stainless Steel      | 200°F | 14692E   | V20.3 | \$412.08   |
| Stainless Steel      | 286°F | 14692G   | V20.3 | \$412.08   |
| Std Sprinkler Wrench |       | 10896W/B | V20   | \$56.27    |



**Microfast® - Stainless Steel**  
**CORROSION RESISTANT**  
**Quick Response**  
**Standard Coverage**  
**Glass Bulb**  
**Stainless Steel - Pendent**  
SIN: VK339  
K Factor: 5.6 (81)  
Thread Size: 1/2 inch NPT  
Base Part #: 14693

| Finish               | Temp  | Part #   | IPG   | List Price |
|----------------------|-------|----------|-------|------------|
| Stainless Steel      | 135°F | 14693A   | V20.3 | \$412.08   |
| Stainless Steel      | 155°F | 14693B   | V20.3 | \$412.08   |
| Stainless Steel      | 175°F | 14693D   | V20.3 | \$412.08   |
| Stainless Steel      | 200°F | 14693E   | V20.3 | \$412.08   |
| Stainless Steel      | 286°F | 14693G   | V20.3 | \$412.08   |
| Std Sprinkler Wrench |       | 10896W/B | V20   | \$56.27    |

**Cocoon Style Sprinklers - Standard Coverage, Quick Response**



**Cocoon sprinkler package includes the following:**

- Pendent or horizontal sidewall sprinkler with protective cap or clip
- Model E-1 two-piece escutcheon (adapter threaded onto sprinkler)
- Three wraps of tape on threads
- Entire unit is protected by plastic cap
- Escutcheon cup is included in separate box

\* NOTE: Other pendent and horizontal sidewall sprinklers are available in cocoon configuration upon request.

**Pendent - Cocoon Sprinkler - QR**  
SIN: VK302  
K Factor: 5.6 (81)  
Thread Size: 1/2 inch NPT  
Base Part #: 06662

| Finish                       | Temp  | Part #     | IPG | List Price |
|------------------------------|-------|------------|-----|------------|
| Chrome                       | 135°F | 06662BFAK  | V00 | \$50.36    |
| Chrome                       | 155°F | 06662BFBK  | V00 | \$50.36    |
| Chrome                       | 175°F | 06662BFDK  | V00 | \$50.36    |
| Chrome                       | 200°F | 06662BFEK  | V00 | \$50.36    |
| White-Polyester <sup>1</sup> | 135°F | 06662MA/WK | V00 | \$50.36    |
| White-Polyester              | 155°F | 06662MB/WK | V00 | \$50.36    |
| White-Polyester              | 175°F | 06662MD/WK | V00 | \$50.36    |
| White-Polyester              | 200°F | 06662ME/WK | V00 | \$50.36    |

**HIGH PRESSURE - VK317 - 5.6 (81) K Factor - Pendent**

|                              |       |            |     |          |
|------------------------------|-------|------------|-----|----------|
| Chrome                       | 135°F | 12282FAK   | V00 | \$52.26  |
| Chrome                       | 155°F | 12282FBK   | V00 | \$52.26  |
| Chrome                       | 175°F | 12282FDK   | V00 | \$52.26  |
| Chrome                       | 200°F | 12282FEK   | V00 | \$52.26  |
| White-Polyester <sup>1</sup> | 135°F | 12282MA/WK | V00 | \$52.26  |
| White-Polyester              | 155°F | 12282MB/WK | V00 | \$52.26  |
| White-Polyester              | 175°F | 12282MD/WK | V00 | \$52.26  |
| White-Polyester              | 200°F | 12282ME/WK | V00 | \$52.26  |
| Std Sprinkler Wrench         |       | 10896W/B   | V20 | \$56.27  |
| Wrench for Recessed          |       | 16036W/B   | V20 | \$115.04 |

**Horizontal Sidewall - Cocoon Sprinkler - QR**  
SIN: VK305  
K Factor: 5.6 (81)  
Thread Size: 1/2 inch NPT  
Base Part #: 12121

| Finish                       | Temp  | Part #     | IPG | List Price |
|------------------------------|-------|------------|-----|------------|
| Chrome                       | 135°F | 12121ABK   | V00 | \$64.26    |
| Chrome                       | 155°F | 12121FBK   | V00 | \$64.26    |
| Chrome                       | 175°F | 12121FDK   | V00 | \$64.26    |
| Chrome                       | 200°F | 12121FEK   | V00 | \$64.26    |
| White-Polyester <sup>1</sup> | 135°F | 12121MA/WK | V00 | \$64.26    |
| White-Polyester              | 155°F | 12121MB/WK | V00 | \$64.26    |
| White-Polyester              | 175°F | 12121MD/WK | V00 | \$64.26    |
| White-Polyester              | 200°F | 12121ME/WK | V00 | \$64.26    |

|                      |          |     |          |
|----------------------|----------|-----|----------|
| Std Sprinkler Wrench | 10896W/B | V20 | \$56.27  |
| Wrench for Recessed  | 13655W/B | V20 | \$118.26 |

